

Gebruikshandleiding
User manual
Pflegeanleitung

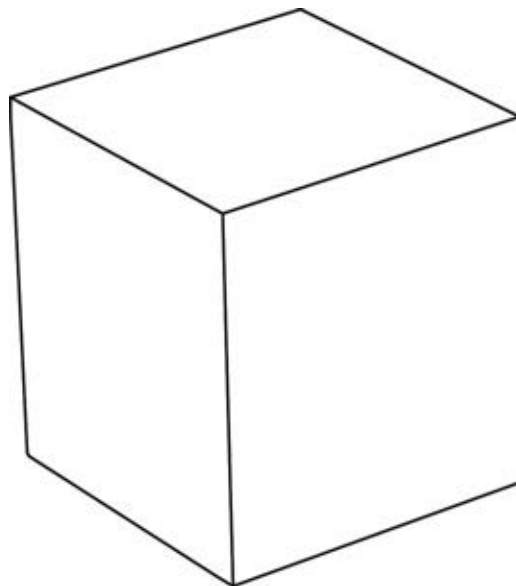

Flex Seat
Flex seat M / L / XL / XXL Flex Seat
Round

Flex Cushion
Flex Cushion M / L / XL / XXL

Urheberrechte

Alle in diesem technischen Dokument enthaltenen Informationen sowie die von uns zur Verfügung gestellten Zeichnungen und technischen Beschreibungen bleiben unser Eigentum und dürfen nur mit unserer Genehmigung vervielfältigt werden. Wir behalten uns Änderungen vor, die aus der ständigen Weiterentwicklung unserer Erzeugnisse resultieren.

Aktueller Stand: 07.07.2014

Copyright

All information contained in this technical document, as well as the drawings and technical descriptions made available by us, remain our property and may not be copied without our permission. We reserve the right to make changes in the interests of further development.

Current as of: 20/10/2014

Copyright

Alle informatie in dit technische document, evenals de tekeningen en technische beschrijvingen beschikbaar gesteld door ons, blijven ons eigendom en mogen niet worden gekopieerd zonder onze toestemming. Wij behouden ons het recht voor om wijzigingen aan te brengen in het belang van verdere ontwikkeling.

Actueel op: 20/10/2014

Inhoudsopgave

Voorwoord, veiligheid, gebruik & onderhoud	4
Dimensionering Flex Seat.....	5
Dimensionering Flex Seat Round.....	6
Dimensionering Flex Cushion.....	7

Voorwoord

Veiligheid, gebruik & onderhoud

Voorwoord :

Deze handleiding bevat de belangrijkste aanwijzingen voor het gebruik en onderhoud van de Cleopatra soft touch zitelementen. Leest u deze handleiding aandachtig door.











Onjuist gebruik en onderhoud kan leiden tot schade en/of persoonlijk letsel.

Correct gebruik :

De Cleopatra Flex Seat zitelementen dienen uitsluitend te worden gebruikt in combinatie met (bouwkundige) stoom (douche) cabines. Iedere andere toepassing geldt als onrechtmatig en is daardoor voor eigen risico van de gebruiker. Onrechtmatig is bijvoorbeeld de toepassing als opstapje. De fabrikant is in dit geval niet aansprakelijk voor eventuele (gevolg) schade/letsel.

Maximale omgevingstemperatuur 55°C

Belasting:

Model	Max. belasting (kg)	Aantal personen
Flex Seat	100	
Flex Seat Round	100	
Flex Seat M	100	 of 
Flex Seat L	100	 of 
Flex Seat XL	200	 of 
Flex Seat XXL	200	 of 

Onderhoud :

De Flex Seat coating neemt nauwelijks iets op, waardoor verse vlekken eenvoudig met water kunnen worden weggespoeld. Gebruik hiervoor nooit een hogedruk-reiniger omdat deze kleine scheurtjes in de coating veroorzaken. Een harde lauw /warme waterstraal uit een handdouche is een goede manier van reinigen. Gebruik eventueel een natte doek om vlekken te verwijderen. Naspoeien met schoon lauw/warm water.

Opmerking :

Na intensief gebruik kunnen er plaatselijk plooiën in de coating ontstaan. Dit doet geen afbreuk aan de kwaliteit van het product en valt daarom buiten de garantie.

Na het uit de verpakking nemen kan het zitelement een op afstand merkbare geur afscheiden.

Dit kan geen kwaad en verdwijnt na korte tijd vanzelf. We adviseren het zitelement pas in de stoom-douche cabine te plaatsen als deze geur grotendeels verdwenen is.

Waarschuwing:

- Niet op de flex seat gaan staan!
- Niet optillen als iemand op de flex seat zit!



Dimensioning Flex Seat

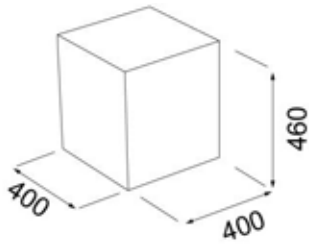

FLEX SEAT

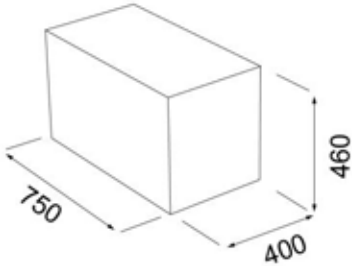
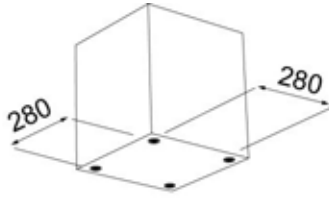

FLEX SEAT M

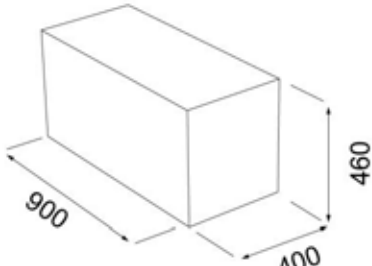
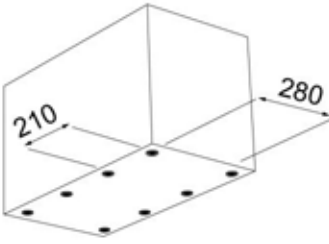

FLEX SEAT L

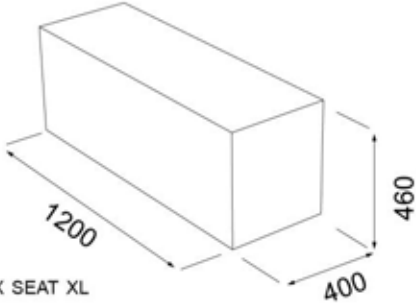
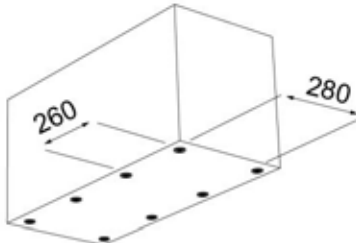

FLEX SEAT XL

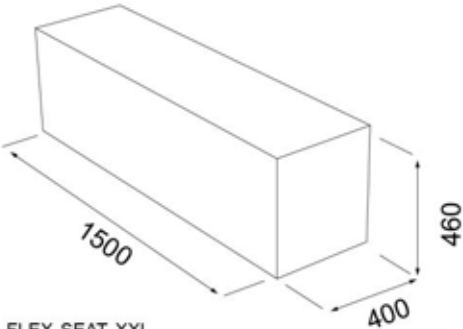
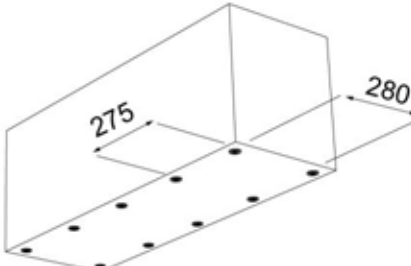

FLEX SEAT XXL

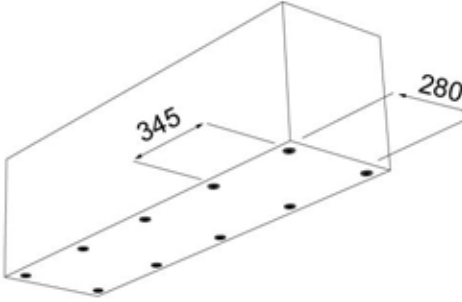

Dimensioning Flex Seat Round

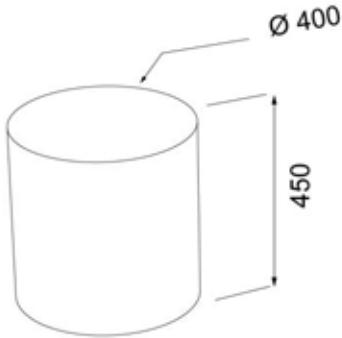

FLEX SEAT ROUND

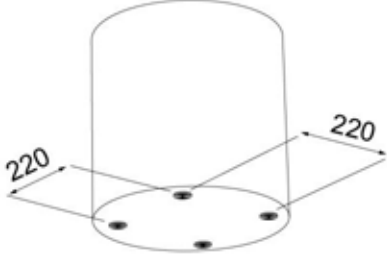

Dimensioning Flex Cushion

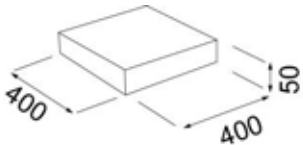

FLEX CUSHION

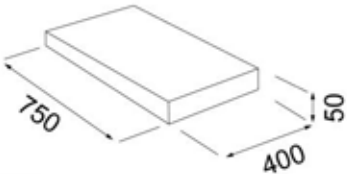

FLEX CUSHION M

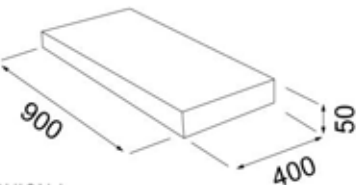

FLEX CUSHION L

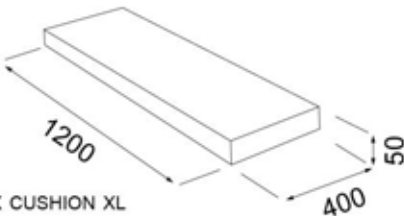

FLEX CUSHION XL

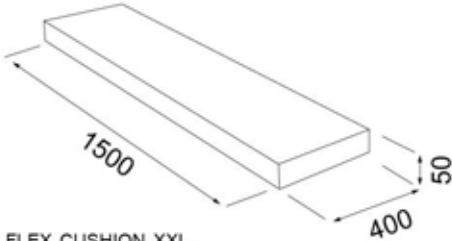

FLEX CUSHION XXL

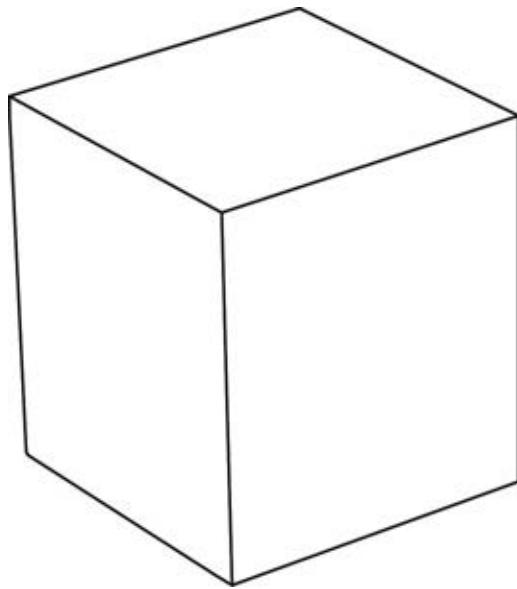

Manual

Flex Seat

Flex seat M / L / XL / XXL

Flex Seat Round

Flex Cushion

Flex Cushion M / L / XL / XXL

Table of content

Foreword, Safety & Technical specifications.....	4
Dimensions Flex Seat.....	5
Dimensions Flex Seat Round.....	6
Dimensions Flex Cushion.....	7

Foreword, Safety & Technical specifications

Foreword:











This manual contains the most important directions for using and maintaining the Cleopatra Flex Seat seat elements. Read this manual carefully. Improper use or maintenance can lead to damage and / or personal injuries.

Proper use:

The Cleopatra Flex Seat, seat elements can only be used in combination with (constructual) steam (shower) cabins. Any other use, such as using it as a step, is considered improper use. Cleopatra accepts no liability for any damage or injuries caused by improper use.

Maximum temperature: 55°C

Load:

Model	Max. load (kg)	Number of people
Flex Seat	100	
Flex Seat Round	100	
Flex Seat M	100	 or 
Flex Seat L	100	 or 
Flex Seat XL	200	 or 
Flex Seat XXL	200	 or 

Maintenance:

The coating of the Flex Seat is dirt repellent. Fresh stains and dirt can easily be removed with water. Never use a pressure cleaner. Pressure cleaners can cause cracks and tears in the surface of the Flex Seat. Use a hard lukewarm spray from the hand shower to clean the Flex Seat or a damp cloth to remove stains and dirt. Rinse with lukewarm water.

Remark:

After intense use local wrinkles can form in the surface of the Flex Seat. This doesn't affect the quality of the product and is not covered by warranty. After unpacking the Flex Seat, the product can release a noticeable smell. The odours being released by the Flex Seat are not harmful. The smell will go away after a short period of time. Cleopatra advises not to use the Flex Seat inside a steam cabin until the odour is gone

Warning:

- Do not stand on the flex seat!
- Don't lift the Flex Seat when a person is sitting on it.



Technical specifications:

- Foam: Eupen, superE
- Coating: Rocathaan Hotspray Pa 250
- Leg cap: PE, black

Dimensions Flex Seat

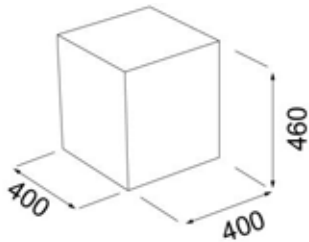

FLEX SEAT

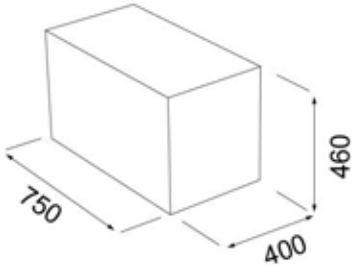
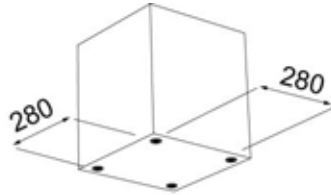

FLEX SEAT M

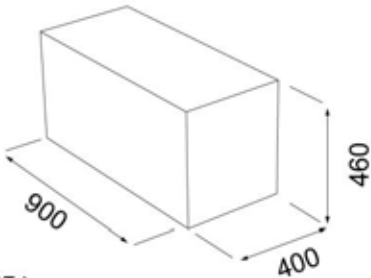
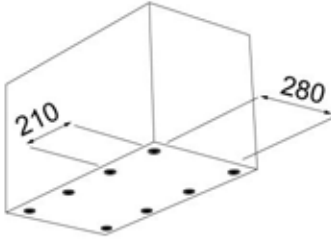

FLEX SEAT L

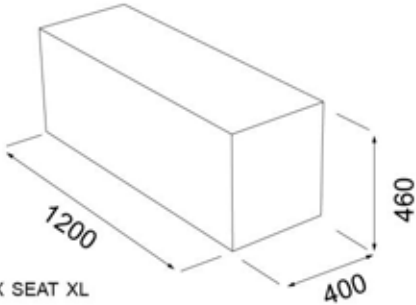
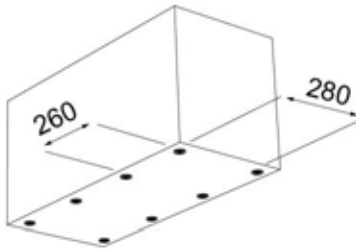

FLEX SEAT XL

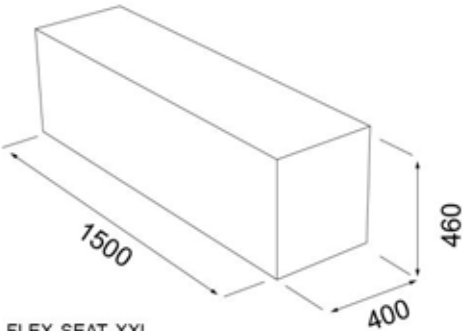
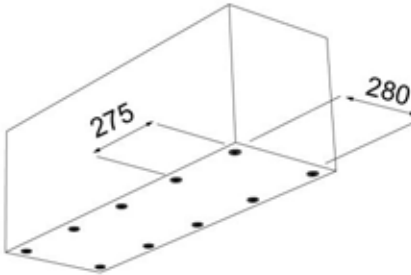

FLEX SEAT XXL

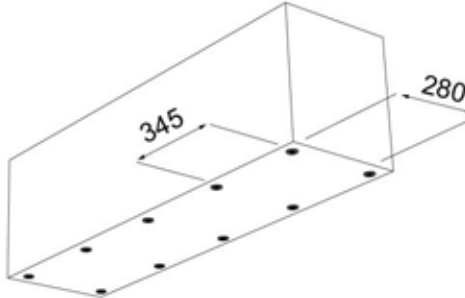

Dimensions Flex Seat Round

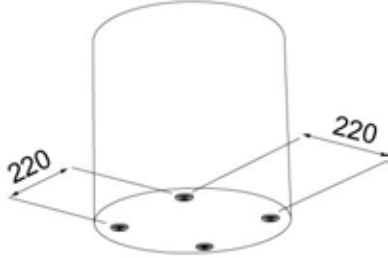
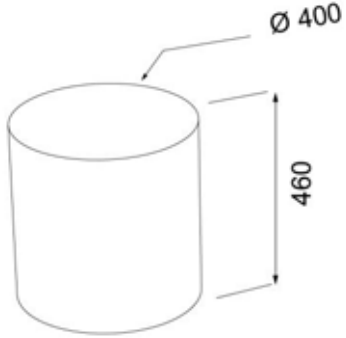

FLEX SEAT ROUND

Dimensions Flex Cushion

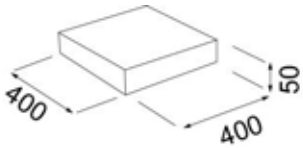

FLEX CUSHION



FLEX CUSHION M

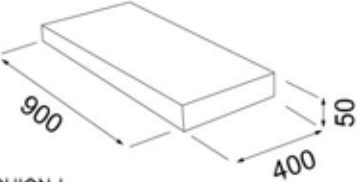

FLEX CUSHION L

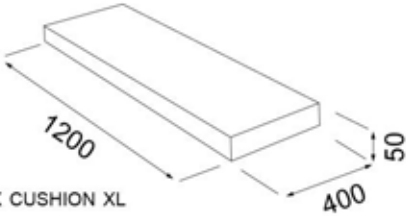

FLEX CUSHION XL

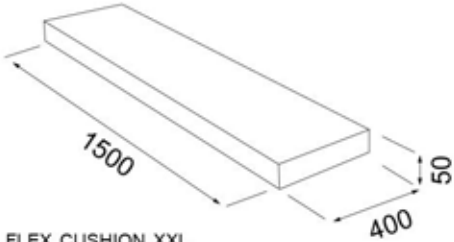

FLEX CUSHION XXL

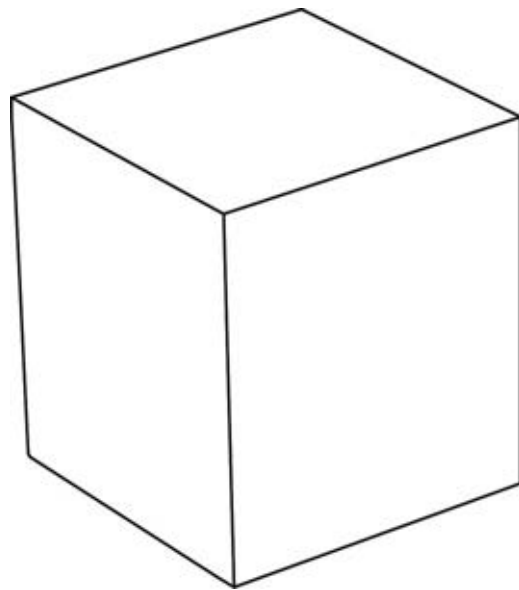

Gebrauchs- und Pflegehinweise

Flex Seat
Flex seat M / L / XL / XXL
Flex Seat Round

Flex Cushion
Flex Cushion M / L / XL / XXL

Inhaltverzeichnis

Vorwort, Sicherheit & Produktkennzeichnung	4
Abmessungen Flex Seat.....	5
Abmessungen Flex Seat Round	6
Abmessungen Flex Cushion	7

Vorwort, Sicherheit & Produktkennzeichnung

Vorwort :

Diese Anleitung enthält wichtige Anweisungen für die Nutzung und die Pflege der Flex Seat-Sitzelemente von Cleopatra. Bitte lesen Sie diese Anleitung sorgfältig durch. Unsachgemäße Nutzung und Pflege können Verletzungen und / oder Personenschäden verursachen.

Anwendungsbereich:

Die Cleopatra Flex Seat-Sitzelemente dürfen nur zusammen mit der (Einbau-) Dampf- bzw. Duschkabine verwendet werden. Andere Anwendungen sind nicht zulässig und unterliegen dann dem Risiko des Eigentümers. Eine unsachgemäße Anwendung ist beispielsweise die Nutzung der Elemente als Trittleiter. Der Hersteller und Inverkehrbringen haftet nicht für auftretende (Folge-) Schäden oder Verletzungen, die durch den Missbrauch entstanden sind. Maximale Umgebungstemperatur 55°C

Belastung:

Modell	Max. belastung (kg)	Max. anzahl der Personen
Flex Seat	100	
Flex Seat Round	100	
Flex Seat M	100	 oder 
Flex Seat L	100	 oder 
Flex Seat XL	200	 oder 
Flex Seat XXL	200	 oder 

Reinigung:

Die Flex Seat-Beschichtung wirkt abweisend, so das frische Verunreinigungen problemlos mit Wasser abgewaschen werden können. Verwenden Sie niemals einen Hochdruckreiniger, da dieser kleine Risse in der Beschichtung verursacht. Die Verwendung eines harten warm/heißen Wasserstrahls aus der Handbrause stellt eine gute Reinigungsmöglichkeit dar. Benutzen Sie ein nasses Synthetiktuch (Mikrofaser), um die Verunreinigungen zu entfernen. Spülen sie mit klarem warm / heißem Wasser ab.

Bemerkung:

Nach intensiver oder einseitiger Benutzung können Falten im Material entstehen. Dies führt nicht zur Beeinträchtigung der Qualität des Produktes und ist deswegen nicht von der Garantie abgedeckt. Nach dem Auspacken kann das Material möglicherweise einen merklichen Geruch abgeben. Dies ist harmlos und nach kurzer Zeit nicht mehr bemerkbar. Wir empfehlen Ihnen das Soft-Touch-Sitzelement erst dann in der Kabine zu benutzen, nachdem sich der Geruch größtenteils verflüchtigt hat.

Warnung:

- Nicht auf den Sitz treten!
- Nicht mit Person anheben!



Technische Daten:

- Schaum: Eupen, superE
- Überzug: Rocathaan Hotspray Pa 250
- Kappe: PE, schwarz

Abmessungen Flex Seat

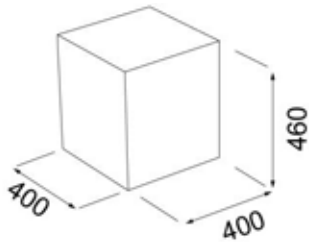

FLEX SEAT

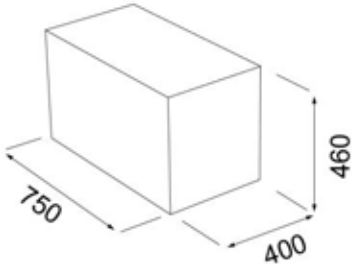
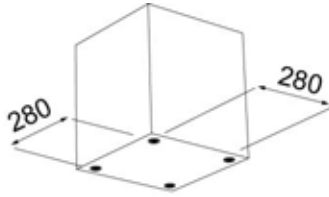

FLEX SEAT M

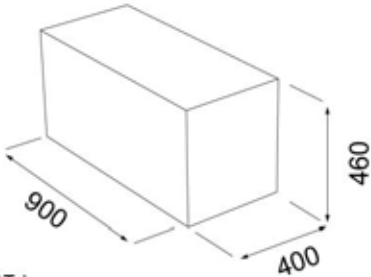
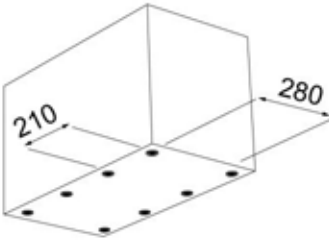

FLEX SEAT L

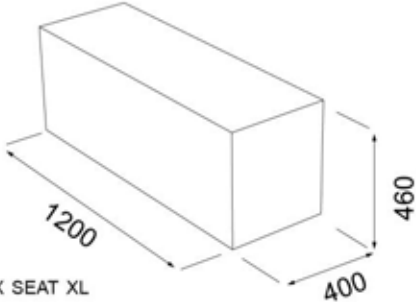
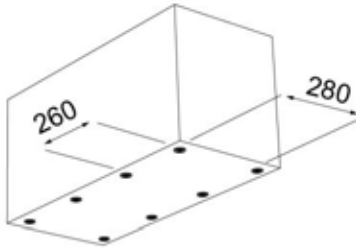

FLEX SEAT XL

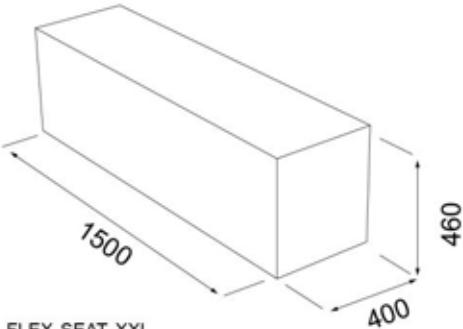
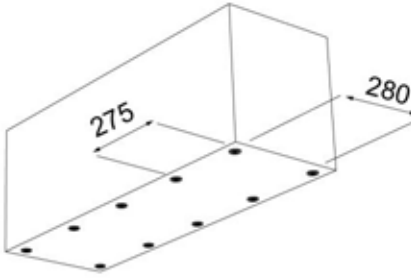

FLEX SEAT XXL

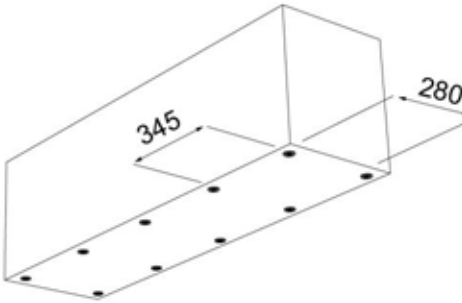

Abmessungen Flex Seat Round

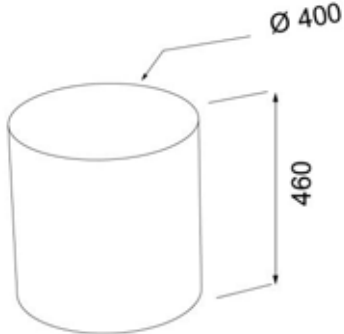

FLEX SEAT ROUND

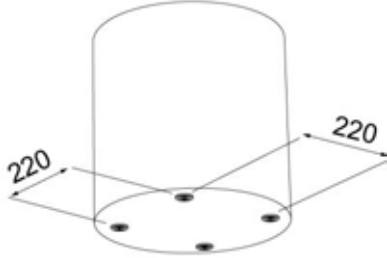

Abmessungen Flex Cushion

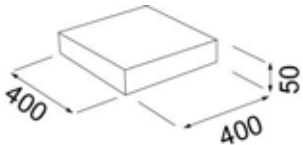

FLEX CUSHION

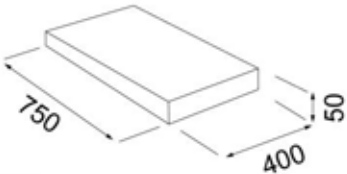

FLEX CUSHION M

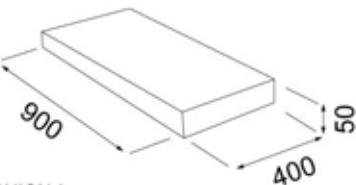

FLEX CUSHION L

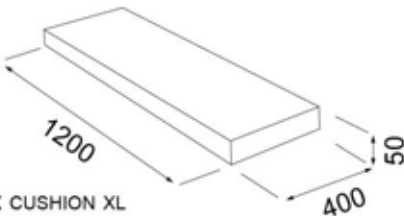

FLEX CUSHION XL

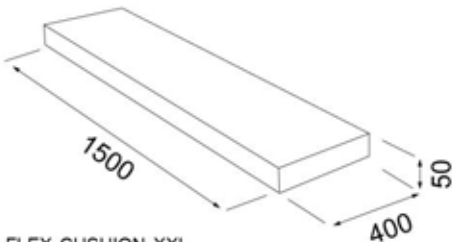

FLEX CUSHION XXL

Installations- und Betriebsanleitung Flex Seat & Cushion. Wir behalten uns das Recht vor, technische Änderungen und druckbedingte Farbänderungen vorzunehmen.
Artikelnr. 90175501. Gedruckt in den Niederlanden.
01.2015

Cleopatra B.V. · Oostzijde 295 · 1508 EN Zaandam
Phone: +31 75-647 82 00 · info@cleopatra.nl ·
www.cleopatra.nl