

PROFESSIONAL STEAM

EXCLUSIVE PROFESSIONAL WELLNESS

CLEOPATRA
world of wellness

www.cleopatra.nl



Copyright © 2023 Cleopatra BV

Cleopatra B.V.
Oostzijde 295
1508 EN Zaandam
Netherlands

www.cleopatra.nl
www.cleopatra-wellness.com

No part of this publication may be reproduced, stored in a computerised database or published in any form or by any means, whether electronic, mechanical, photocopying, recording or any other means, without prior written permission from Cleopatra B.V.

General terms and conditions of Cleopatra B.V. apply. Price and model changes reserved.

PROFESSIONAL STEAM

TABLE OF CONTENTS

Vogue line overview	4	Steam generator options	
Online configurator	6	Ultrasteam	44
Vogue line models		Climate control	46
Vogue Essential	8	Hygiene	46
Vogue Comfort	10	Fragrance dosage	46
Vogue Superior	12	Energy saving	47
Vogue Exclusive	14	Music	47
		Control via extreme source	47
Colour overview	18	Exploded views	
Options		Cleo Basic ^{pro}	48
Banks	21	Cleo Total ^{pro}	49
Spa Comfort	21	Cleo Vital ^{pro} & Elite ^{pro}	50
Shower options	21	Spare parts	51
Steam inlet	21		
Roofs	21	Generator dimensions	54
Drawings		Water quality	55
Vogue 1250	26	Power versus Volume	55
Vogue 1500	27		
Vogue 2000	28	Wellness automation	56
Vogue 2500	30	Payment terminal	60
Vogue 3000	32	Energy savings	62
Vogue Exclusive	33	Fragrances	64
Steam generators	35	Product data sheets	
Cleo Basic pro	36	Vogue line	66
Cleo Vital pro	38	Steam generators	68
Cleo total pro	40		
Cleo Elite pro	42		

FEATURES

- Prefab cabin made of insulated panels 43 mm
- Walls, roof and bench finished (page 18)
- Various sizes; available in 3 versions: Essential, Comfort or Superior
- Bank model square is standard
- Customised cabins are possible
- Colour frame M1 door white (RAL)
- Cabin to be placed on a finished floor
- Easy installation and maintenance
- Cabin can be used as a steam bath, shower and hammam
- Matching professional steam generator (page 35)

OPTIONS WITHOUT

- Glass colour: transparent, bronze or smoked grey
- Door hinge direction: front hinges right or left
- Interior colours: textured, matt or glossy (page 18)

OPTIONS WITH SURCHARGE

- Window(s)
Optional thermostatic mixer, hand shower, shower rod
- Experience shower (rooftop shower, colour light and music)
- Aroma bath (multi-scented)
- Hamam or Turkish bath generator (page 35)
- Colour therapy
- Spa comfort: seat cushions & loungers
- Wider benches (XL), double benches (double XL)



VOGUE LINE ESSENTIAL

- Flat roof white RAL (9016) including venting
- Roof including LED RGB spotlights
- 28 standard sizes available
- Customisation possible
- Door included (RAL 9003)
- Including mounting material

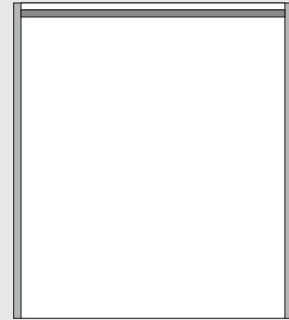

VOGUE LINE COMFORT

- Suspended roof white RAL (9016) including ventilation
- Roof including LED Rails on 2 sides
- 28 standard sizes available
- Customisation possible
- Door included (RAL 9003)
- Including mounting material

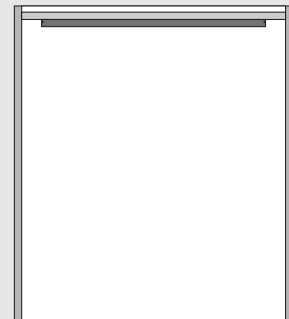

VOGUE LINE SUPERIOR

- Dome roof white RAL (9016) including venting
- Roof including LED Rails on 2 sides
- 28 standard sizes available
- Customisation possible
- Door included (RAL 9003)
- Including mounting material

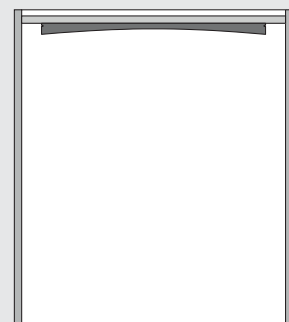

VOGUE LINE EXCLUSIVE

- 8-corner cabins
- Suspended roof RAL (9016) including LED spotlights
- 2 standard sizes available
- Door included (RAL 9003)
- Including venting
- Including mounting material

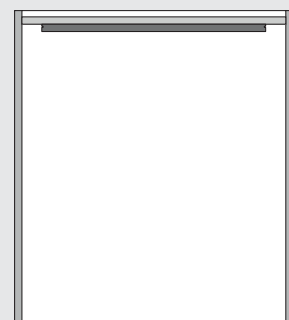

ONLINE CONFIGURATOR

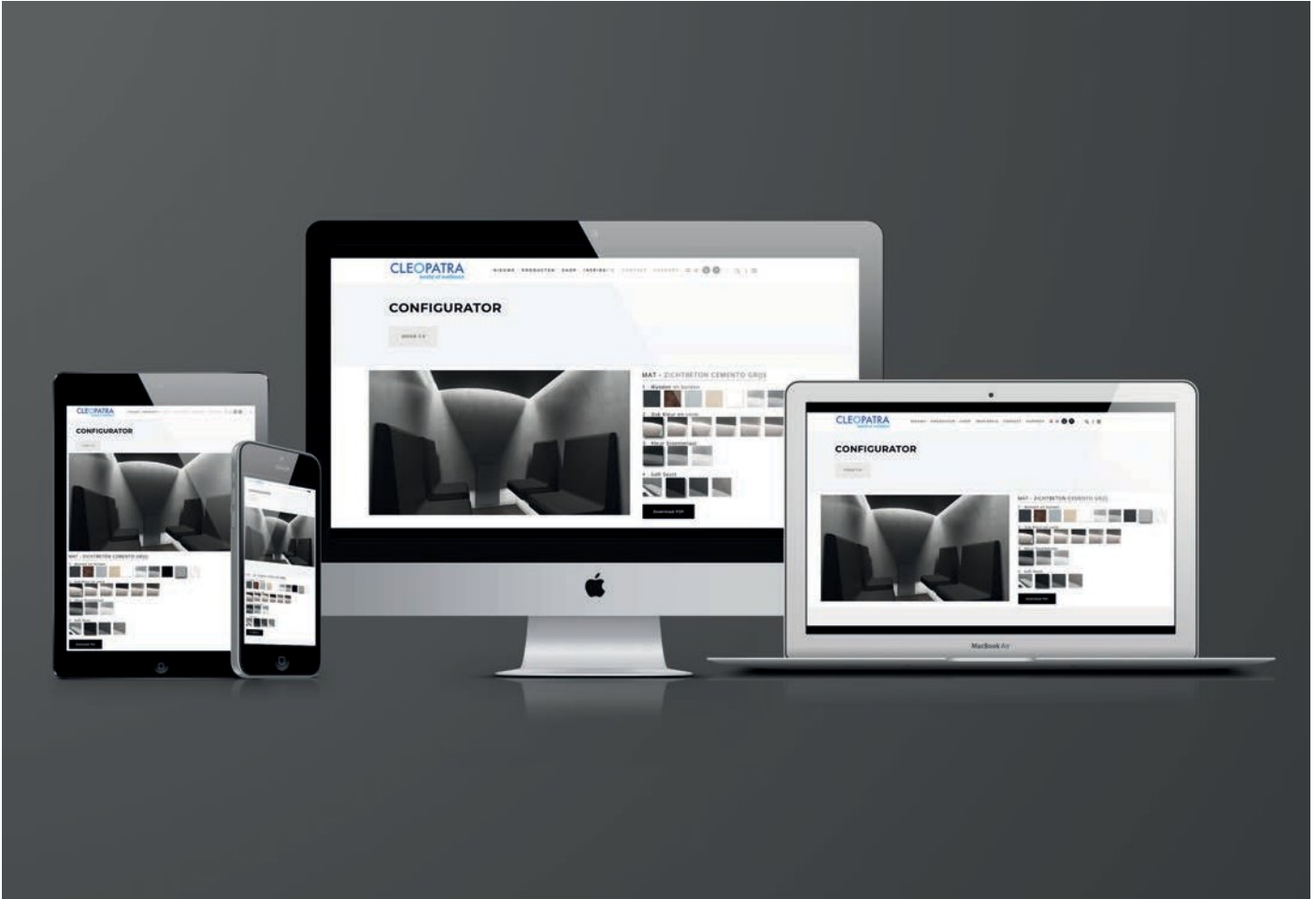

Do you have special requirements and would like to see what your cabin will look like? Then try our online configurator at: www.cleopatra.nl. Some examples are shown on the following pages.

Flat roof, lowered or curved

Wall and bench finished

Steam inlet



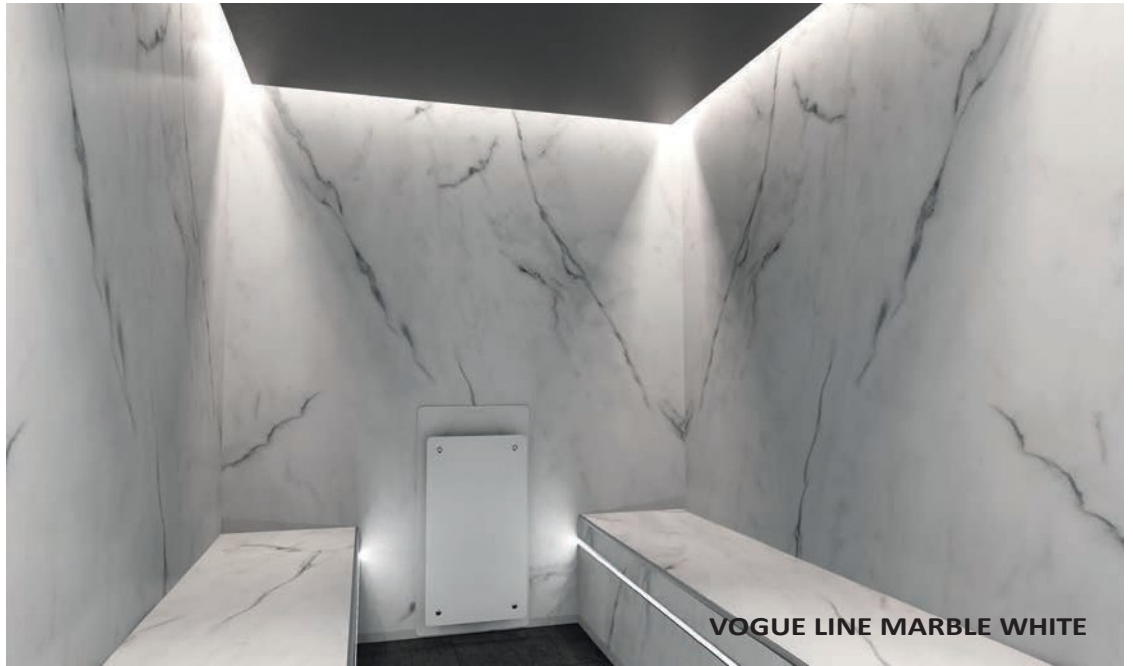

VOGUE LINE MARBLE WHITE

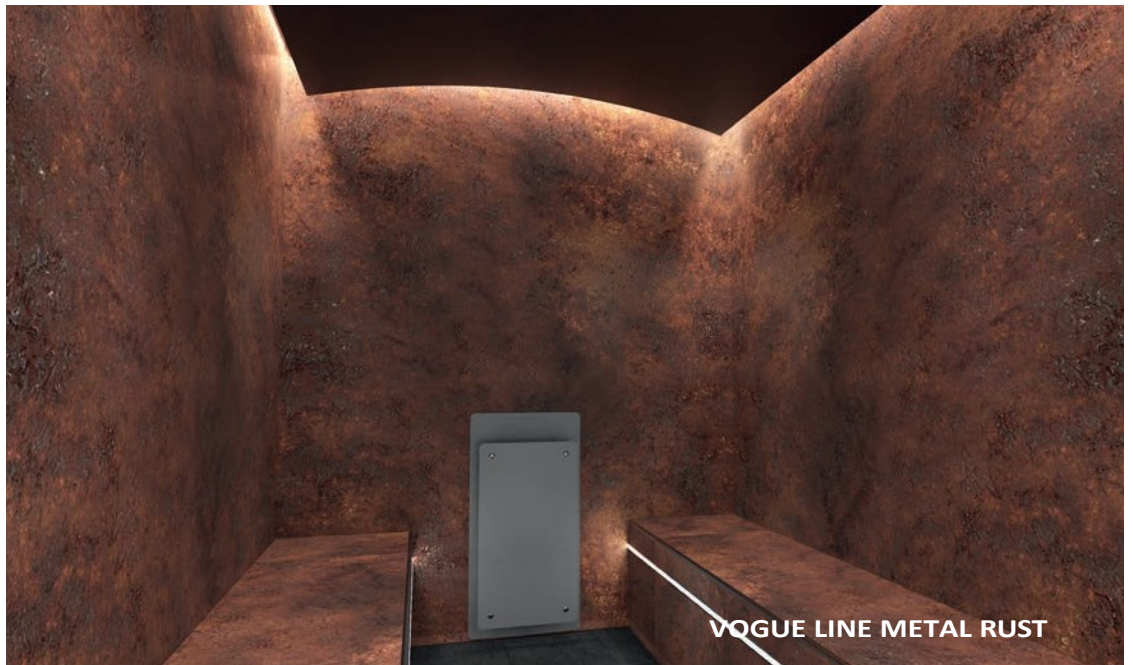

VOGUE LINE METAL RUST



VOGUE LINE GRAPHITE GREY

VOGUE LINE ESSENTIAL

DESCRIPTION	ARTICLE NO	W (mm)	D (mm)	kW
Vogue 1250 - Essential M1 - 1	82005010	1250	1000	3
Vogue 1250 - Essential M1 - 2	82005015	1250	1250	4
Vogue 1250 - Essential M1 - 3	82005020	1250	1500	4
Vogue 1500 - Essential M1 - 4	82005025	1500	1000	3
Vogue 1500 - Essential M1 - 5	82005030	1500	1250	4
Vogue 1500 - Essential M1 - 6	82005035	1500	1500	5
Vogue 1500 - Essential M1 - 7	82005040	1500	1750	6
Vogue 1500 - Essential M1 - 8	82005045	1500	2000	7
Vogue 2000 - Essential M1 - 9	82005050	2000	1000	5
Vogue 2000 - Essential M1 - 10	82005055	2000	1500	7
Vogue 2000 - Essential M1 - 11	82005060	2000	2000	9
Vogue 2000 - Essential M1 - 12	82005065	2000	2500	12
Vogue 2000 - Essential M1 - 13	82005070	2000	3000	14
Vogue 2000 - Essential M1 - 14	82005075	2000	3500	16
Vogue 2000 - Essential M1 - 15	82005080	2000	4000	18
Vogue 2500 - Essential M1 - 16	82005085	2500	1500	9
Vogue 2500 - Essential M1 - 17	82005090	2500	2000	12
Vogue 2500 - Essential M1 - 18	82005095	2500	2500	14
Vogue 2500 - Essential M1 - 19	82005100	2500	3000	17
Vogue 2500 - Essential M1 - 20	82005105	2500	3500	20
Vogue 2500 - Essential M1 - 21	82005110	2500	4000	23
Vogue 2500 - Essential M1 - 22	82005115	2500	4500	26
Vogue 3000 - Essential M1 - 23	82005120	3000	2000	14
Vogue 3000 - Essential M1 - 24	82005125	3000	2500	17
Vogue 3000 - Essential M1 - 25	82005130	3000	3000	21
Vogue 3000 - Essential M1 - 26	82005135	3000	3500	24
Vogue 3000 - Essential M1 - 27	82005140	3000	4000	28
Vogue 3000 - Essential M1 - 28	82005145	3000	4500	31
DOOR & WINDOW OPTIONS				
Door M1 2050 x 1000 mm (front hinge right)	21053006			
Door M1 2050 x 1000 mm (front left hinge)	21053007			
Window M1 2050 x 500 mm	21094003			
Window M1 2050 x 1000 mm	21094010			
Window M1 2050 x 1250 mm	21094015			
Window M1 2050 x 1500 mm	21094020			
Window or Door M1 in RAL colour other than RAL 9016	21053350			

VOGUE LINE ESSENTIAL

- Walls and bench: gloss, textured or matt finish (page 18)
- Walls and roof fully insulated 43 mm
- Bank model square is standard
- Door M1 colour white (RAL 9003) - 2050 x 750 mm
- Flat roof white RAL (9016) including ventilation
- Roof including LED RGB spotlights
- Exclusive professional steam generator (page 35)



Cross section

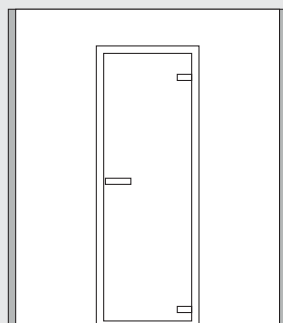

Front view

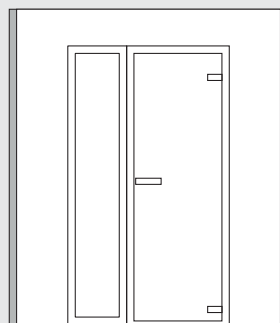

Front view
Door + Window

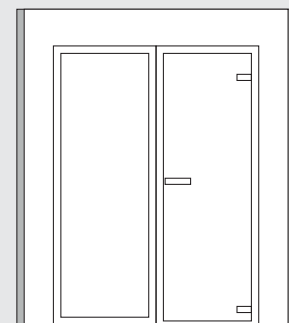

Front view
Door + Window

DESCRIPTION

ARTICLE NO

DESCRIPTION	ARTICLE NO
BANK	
Square bench XL (extra per metre)	82005950
Square bench double XL (extra per metre)	82005960
DOUCHE OPTIONS	
1 function (incl. thermostat, handshower and holder)	28122000
2 function (incl. thermostat, handshower and holder)	28122010
Hand shower and holder	28122020
Raindance roof shower 400 x 400 mm	28122030
STEAM INLET OPTIONS	
Steam inlet glass (2 parts) white	28118100
Steam inlet glass (2 parts) grey	28118200
Steam inlet glass (2 parts) black	28118300
ROOF OPTIONS	
Roof in a different RAL colour	28122800

VOGUE LINE COMFORT

DESCRIPTION	ARTICLE NO	W (mm)	D (mm)	kW
Vogue 1250 - Comfort M1 - 1	82005310	1250	1000	3
Vogue 1250 - Comfort M1 - 2	82005315	1250	1250	4
Vogue 1250 - Comfort M1 - 3	82005320	1250	1500	4
Vogue 1500 - Comfort M1 - 4	82005325	1500	1000	3
Vogue 1500 - Comfort M1 - 5	82005330	1500	1250	4
Vogue 1500 - Comfort M1 - 6	82005335	1500	1500	5
Vogue 1500 - Comfort M1 - 7	82005340	1500	1750	6
Vogue 1500 - Comfort M1 - 8	82005345	1500	2000	7
Vogue 2000 - Comfort M1 - 9	82005350	2000	1000	5
Vogue 2000 - Comfort M1 - 10	82005355	2000	1500	7
Vogue 2000 - Comfort M1 - 11	82005360	2000	2000	9
Vogue 2000 - Comfort M1 - 12	82005365	2000	2500	12
Vogue 2000 - Comfort M1 - 13	82005370	2000	3000	14
Vogue 2000 - Comfort M1 - 14	82005375	2000	3500	16
Vogue 2000 - Comfort M1 - 15	82005380	2000	4000	18
Vogue 2500 - Comfort M1 - 16	82005385	2500	1500	9
Vogue 2500 - Comfort M1 - 17	82005390	2500	2000	12
Vogue 2500 - Comfort M1 - 18	82005395	2500	2500	14
Vogue 2500 - Comfort M1 - 19	82005400	2500	3000	17
Vogue 2500 - Comfort M1 - 20	82005405	2500	3500	20
Vogue 2500 - Comfort M1 - 21	82005410	2500	4000	23
Vogue 2500 - Comfort M1 - 22	82005415	2500	4500	26
Vogue 3000 - Comfort M1 - 23	82005420	3000	2000	14
Vogue 3000 - Comfort M1 - 24	82005425	3000	2500	17
Vogue 3000 - Comfort M1 - 25	82005430	3000	3000	21
Vogue 3000 - Comfort M1 - 26	82005435	3000	3500	24
Vogue 3000 - Comfort M1 - 27	82005440	3000	4000	28
Vogue 3000 - Comfort M1 - 28	82005445	3000	4500	31
DOOR & WINDOW OPTIONS				
Door M1 2050 x 1000 mm (front hinge right)	21053006			
Door M1 2050 x 1000 mm (front left hinge)	21053007			
Window M1 2050 x 500 mm	21094003			
Window M1 2050 x 1000 mm	21094010			
Window M1 2050 x 1250 mm	21094015			
Window M1 2050 x 1500 mm	21094020			
Window or Door M1 in RAL colour other than RAL 9016	21053350			

VOGUE LINE COMFORT M1 FRAMED DOOR

- Walls and bench: gloss, textured or matt finish (page 18)
- Walls and roof fully insulated 43 mm
- Bank model square is standard
- Door M1 colour white (RAL 9003) - 2050 x 750 mm
- Suspended flat roof white RAL (9016) including venting
- Roof including LED tracks (2 sides)
- Exclusive professional steam generator (page 35)



Cross section

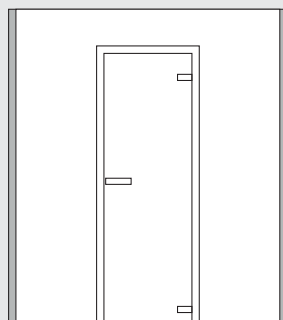

Front view

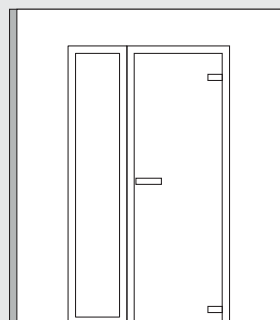

Front view
Door + Window

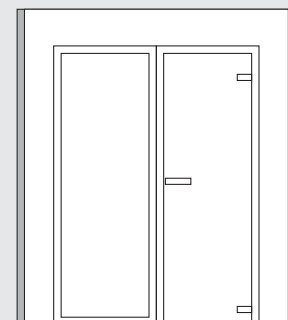

Front view
Door + Window

DESCRIPTION

ARTICLE NO

DESCRIPTION	ARTICLE NO
BANK	
Square bench XL (extra per metre)	82005950
Square bench double XL (extra per metre)	82005960
DOUCHE OPTIONS	
1 function (incl. thermostat, handshower and holder)	28122000
2 function (incl. thermostat, handshower and holder)	28122010
Hand shower and holder	28122020
Raindance roof shower 400 x 400 mm	28122030
STEAM INLET OPTIONS	
Steam inlet glass (2 parts) white	28118100
Steam inlet glass (2 parts) grey	28118200
Steam inlet glass (2 parts) black	28118300
ROOF OPTIONS	
Roof in a different RAL colour	28122800

VOGUE LINE SUPERIOR

DESCRIPTION	ARTICLE NO	W (mm)	D (mm)	kW
Vogue 1250 - Superior M1 - 1	82005610	1250	1000	3
Vogue 1250 - Superior M1 - 2	82005615	1250	1250	4
Vogue 1250 - Superior M1 - 3	82005620	1250	1500	4
Vogue 1500 - Superior M1 - 4	82005625	1500	1000	3
Vogue 1500 - Superior M1 - 5	82005630	1500	1250	4
Vogue 1500 - Superior M1 - 6	82005635	1500	1500	5
Vogue 1500 - Superior M1 - 7	82005640	1500	1750	6
Vogue 1500 - Superior M1 - 8	82005645	1500	2000	7
Vogue 2000 - Superior M1 - 9	82005650	2000	1000	5
Vogue 2000 - Superior M1 - 10	82005655	2000	1500	7
Vogue 2000 - Superior M1 - 11	82005660	2000	2000	9
Vogue 2000 - Superior M1 - 12	82005665	2000	2500	12
Vogue 2000 - Superior M1 - 13	82005670	2000	3000	14
Vogue 2000 - Superior M1 - 14	82005675	2000	3500	16
Vogue 2000 - Superior M1 - 15	82005680	2000	4000	18
Vogue 2500 - Superior M1 - 16	82005685	2500	1500	9
Vogue 2500 - Superior M1 - 17	82005690	2500	2000	12
Vogue 2500 - Superior M1 - 18	82005695	2500	2500	14
Vogue 2500 - Superior M1 - 19	82005700	2500	3000	17
Vogue 2500 - Superior M1 - 20	82005705	2500	3500	20
Vogue 2500 - Superior M1 - 21	82005710	2500	4000	23
Vogue 2500 - Superior M1 - 22	82005715	2500	4500	26
Vogue 3000 - Superior M1 - 23	82005720	3000	2000	14
Vogue 3000 - Superior M1 - 24	82005725	3000	2500	17
Vogue 3000 - Superior M1 - 25	82005730	3000	3000	21
Vogue 3000 - Superior M1 - 26	82005735	3000	3500	24
Vogue 3000 - Superior M1 - 27	82005740	3000	4000	28
Vogue 3000 - Superior M1 - 28	82005745	3000	4500	31
DOOR & WINDOW OPTIONS				
Door M1 2050 x 1000 mm (front hinge right)	21053006			
Door M1 2050 x 1000 mm (front left hinge)	21053007			
Window M1 2050 x 500 mm	21094003			
Window M1 2050 x 1000 mm	21094010			
Window M1 2050 x 1250 mm	21094015			
Window M1 2050 x 1500 mm	21094020			
Window or Door M1 in RAL colour other than RAL 9016	21053350			

VOGUE LINE SUPERIOR

- Walls and bench: gloss, textured or matt finish (page 18)
- Walls and roof fully insulated 43 mm
- Bank model square is standard
- Door M1 colour white (RAL 9003) - 2050 x 750 mm
- Dome flat roof white RAL (9016) including ventilation
- Roof including LED tracks (2 sides)
- Exclusive professional steam generator (page 35)

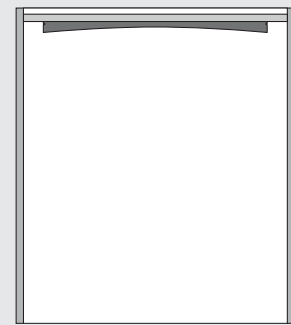

Cross section

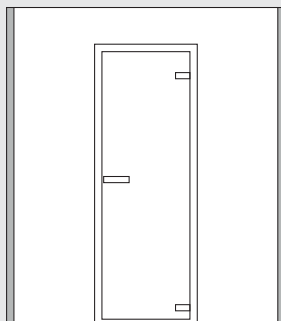

Front view

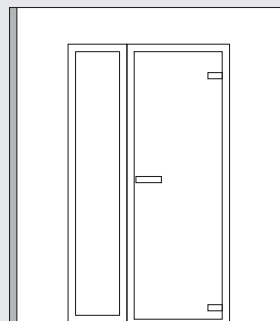

Front view
Door + Window

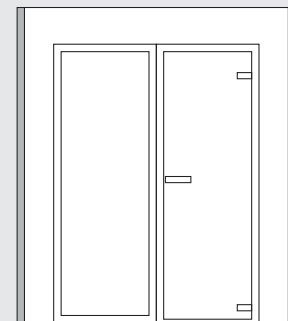

Front view
Door + Window

DESCRIPTION

ARTICLE NO

DESCRIPTION	ARTICLE NO
BANK	
Square bench XL (extra per metre)	82005950
Square bench double XL (extra per metre)	82005960
DOUCHE OPTIONS	
1 function (incl. thermostat, handshower and holder)	28122000
2 function (incl. thermostat, handshower and holder)	28122010
Hand shower and holder	28122020
Raindance roof shower 400 x 400 mm	28122030
STEAM INLET OPTIONS	
Steam inlet glass (2 parts) white	28118100
Steam inlet glass (2 parts) grey	28118200
Steam inlet glass (2 parts) black	28118300
ROOF OPTIONS	
Roof in a different RAL colour	28122800





VOGUE LINE EXCLUSIVE MARBLE BLACK

VOGUE LINE EXCLUSIVE

DESCRIPTION	ARTICLE NO	W (mm)	D (mm)	kW
Vogue 2500 - Exclusive M1 - 1	82005910	2500	2500	11,4
Vogue 3500 - Exclusive M1 - 2	82005920	3500	3500	11,4
Window or Door M1 in RAL colour other than RAL 9016	21053350			
DOUCHE OPTIONS				
1 function (incl. thermostat, handshower and holder)	28122000			
2 function (incl. thermostat, handshower and holder)	28122010			
Hand shower and holder	28122020			
Raindance roof shower 400 x 400 mm	28122030			
STEAM INLET OPTIONS				
Steam inlet glass (2 parts) white	28118100			
Steam inlet glass (2 parts) grey	28118200			
Steam inlet glass (2 parts) black	28118300			
ROOF OPTIONS				
Roof in a different RAL colour	28122800			



VOGUE LINE EXCLUSIVE

- Walls and bench: gloss, textured or matt finish (page 18)
- Walls and roof fully insulated 43 mm
- Bank model square is standard
- Door M1 colour white (RAL 9003) - 2050 x 750 mm
- Suspended flat roof white RAL (9016) including venting
- Roof including LED spotlights (6 pieces)
- Exclusive professional steam generator (page 35)

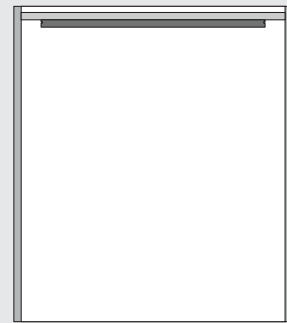

Cross section

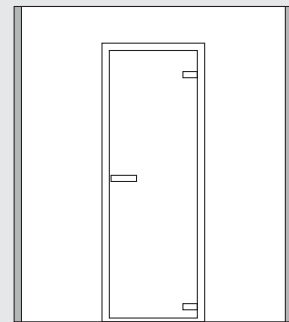

Front view



VOGUE LINE EXCLUSIVE MEDITERRANEAN

VOGUE LINE EXCLUSIVE TERRA GREY

COLOURS OVERVIEW

GLOSS



Artic White

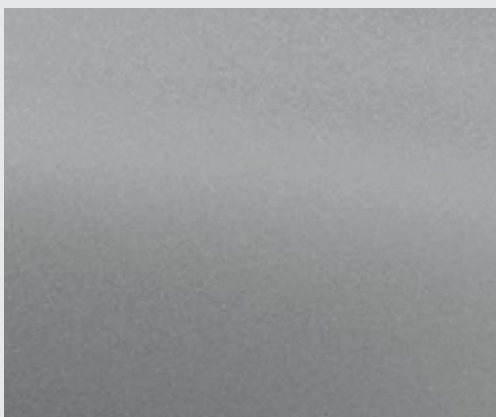

Titan

STRUCTURED

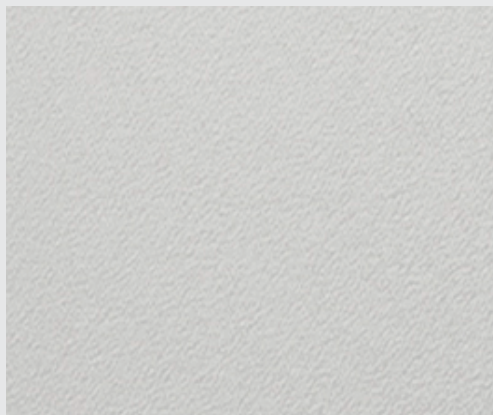

White

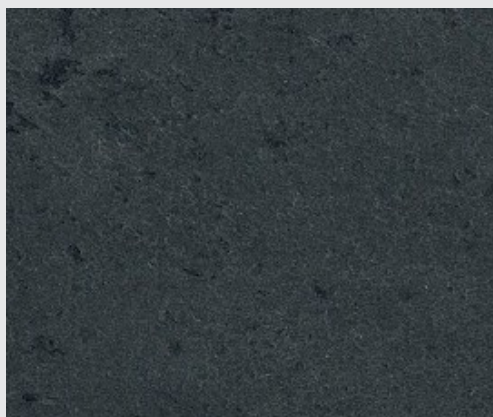

GreyGraphite Grey



Metal rust Red

STRUCTURED



Mediterranean Beige

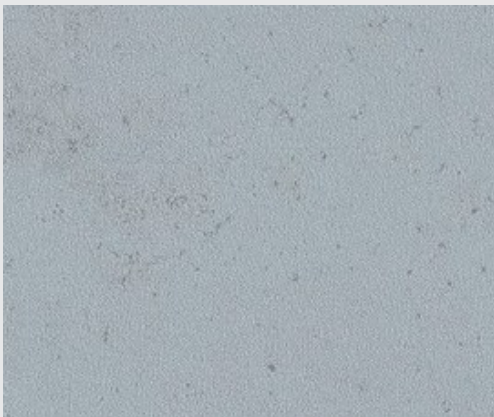

Terra Grey



Other colours on request

MAT



Marble White



Marble Black

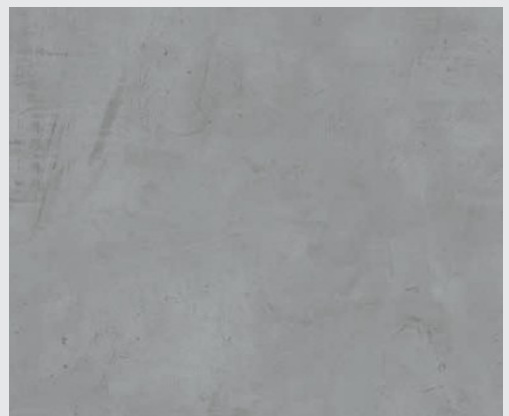

Concrete Grey



VOGUE LINE OPTIONS

DESCRIPTION	ARTICLE NO
BANKS OPTIONS	
Square bench XL (extra per metre)	82005950
Square bench double XL (extra per metre)	82005960
DOOR & WINDOW OPTIONS	
Door M1 2050 x 1000 mm (front hinge right)	21053006
Door M1 2050 x 1000 mm (front left hinge)	21053007
Window M1 2050 x 500 mm	21094003
Window M1 2050 x 1000 mm	21094010
Window M1 2050 x 1250 mm	21094015
Window M1 2050 x 1500 mm	21094020
Window or Door M1 in RAL colour other than RAL 9016	21053350
SPA COMFORT OPTIONS	
Soft seat white (RAL 9016)	28130060
Soft seat grey (RAL 7042)	28130030
Soft seat black (RAL 7021)	28130020
Spa cushion white (RAL 9016) - 750 mm	21093010
Spa cushion grey (RAL 7042) - 750 mm	21093020
Spa cushion black (RAL 7021) - 750 mm	21093617
Spa cushion white (RAL 9016) - 1500 mm	21093013
Spa cushion grey (RAL 7042) - 1500 mm	21093023
Spa cushion black (RAL 7042) - 1500 mm	21093620
Spa cushion XL white (RAL 9016) - 1500 mm	28130350
Spa cushion XL grey (RAL 7042) - 1500 mm	28130320
Spa cushion XL black (RAL 7042) - 1500 mm	28130310
Soft lounge cushion XL white (RAL 9016)	28130450
Soft lounge cushion XL grey (RAL 7042)	28130420
Soft lounge cushion XL black (RAL 7021)	28130410
DOUCHE OPTIONS	
1 function (incl. thermostat, handshower and holder)	28122000
2 function (incl. thermostat, handshower and holder)	28122010
Hand shower and holder	28122020
Raindance roof shower 400 x 400 mm	28122030
STEAM INLET OPTIONS	
Steam inlet glass (2 parts) white	28118100
Steam inlet glass (2 parts) grey	28118200
Steam inlet glass (2 parts) black	28118300
ROOFING OPTIONS	
Roof in a different RAL colour	28122800

BANKS



Square bench (standard)

(dimension page 25)



Square XL bench

instead of square bench (size page 25)



Double square bench

instead of square bench (size page 25)

CUSHIONS



Soft seat

For square bench (dimensions page 24)



Soft flat cushion

(dimensions page 24)



Soft lounge cushion

For square XL bench (dimensions page 24)

WINDOWS & DOORS

DESCRIPTION

ARTICLE NO

Door M1 2050 x 1000 mm (front hinge right)	21053006
Door M1 2050 x 1000 mm (front left hinge)	21053007
Window M1 2050 x 500 mm	21094003
Window M1 2050 x 1000 mm	21094010
Window M1 2050 x 1250 mm	21094015
Window M1 2050 x 1500 mm	21094020
Window or Door M1 in RAL colour other than RAL 9016	21053350



SHOWERS



Hansgrohe Select thermostat 1
Function + Select hand
shower + Shower hose

2812 20 00

Hansgrohe Select thermostat 2
Functions + Select hand
shower + shower hose **2812
20 10**



Hansgrohe Metropol Hand
shower and shower hose

2812 20 20

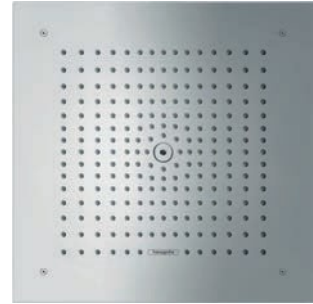

Hansgrohe roof shower
Raindance E 400 x 400 mm

2812 20 30

STEAM INLET



Steam inlet glass (2 parts)

Wh **2811 81 00**



Steam inlet glass (2 parts)

Grey **2811 82 00**



Steam inlet glass (2 parts)

Black **2811 83 00**

VOGUE LINE OPTIONS

Soft seats (optional)

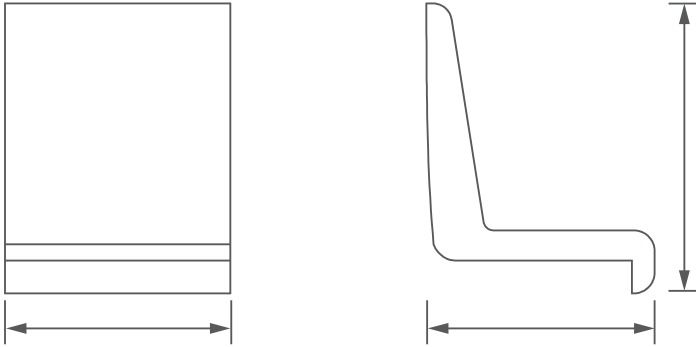

600 x 610 x 770 mm (only for square bench)

- RAL 3018
- RAL 7021
- RAL 7042
- RAL 4001
- RAL 3015
- RAL 9016

Soft flat cushion (optional)



730 x 500 x 50 mm
1480 x 500 x 50 mm
1670 x 670 x 50 mm (square XL only)

- RAL 3018
- RAL 7021
- RAL 7042
- RAL 4001
- RAL 3015
- RAL 9016

Soft lounge cushion (optional)

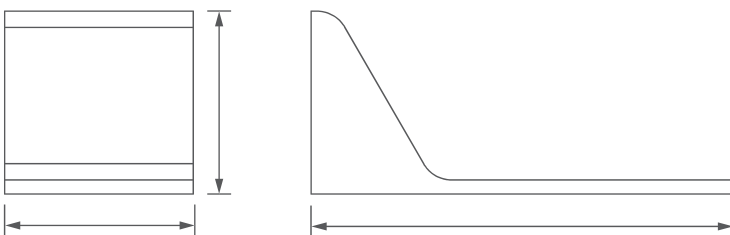

1500 x 670 x 50 mm (only for square XL)

- RAL 3018
- RAL 7021
- RAL 7042
- RAL 4001
- RAL 3015
- RAL 9016

DIMENSIONS OF BENCHES

Square bench (standard)

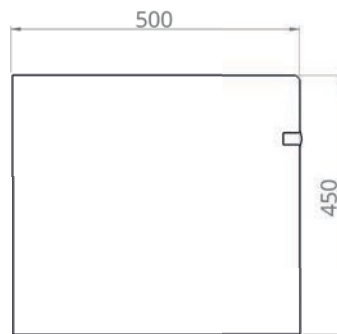

XL Square bench (optional)

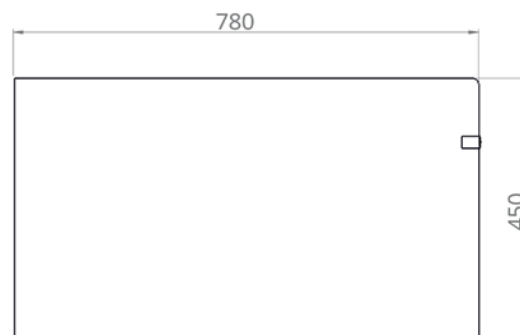

Double Square bench (optional)

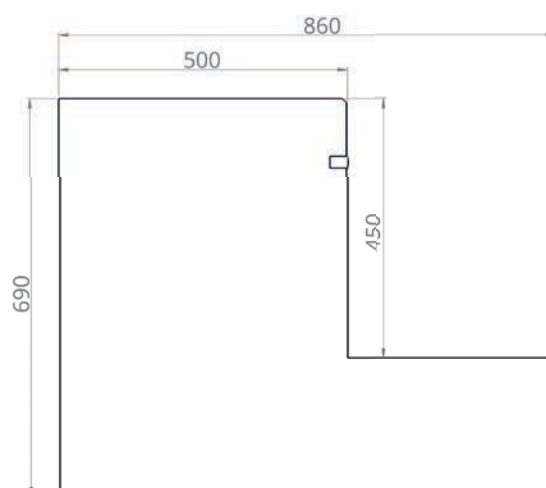

Dimensions in mm.

VOGUE LINE DRAWINGS

MODEL 1250

Other layouts on request

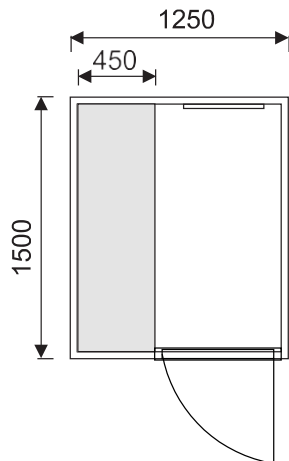
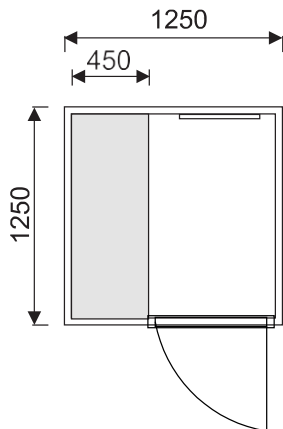
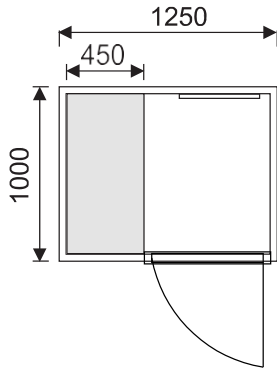

MODEL 1500

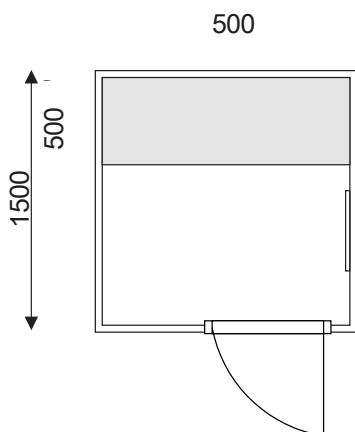
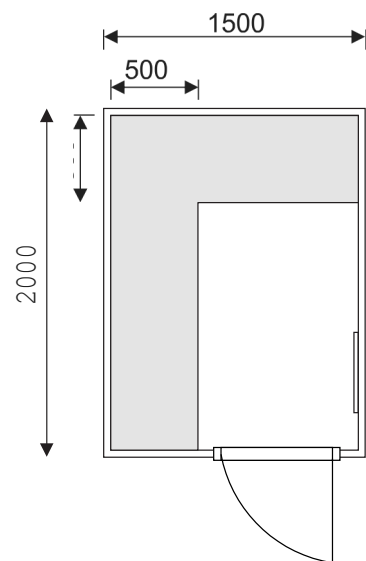
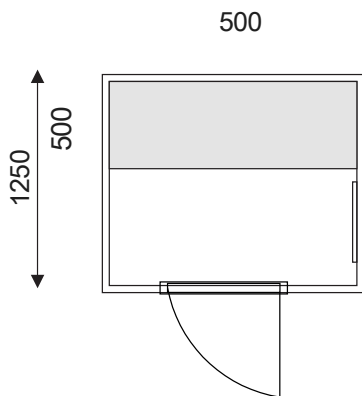
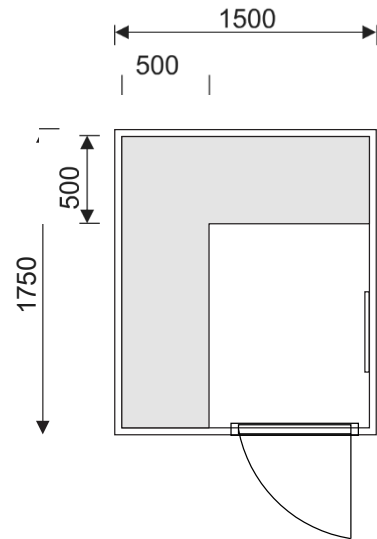
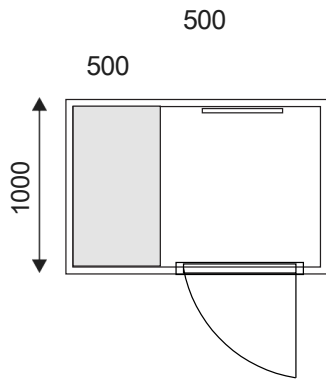

VOGUE LINE DRAWINGS

MODELS 2000

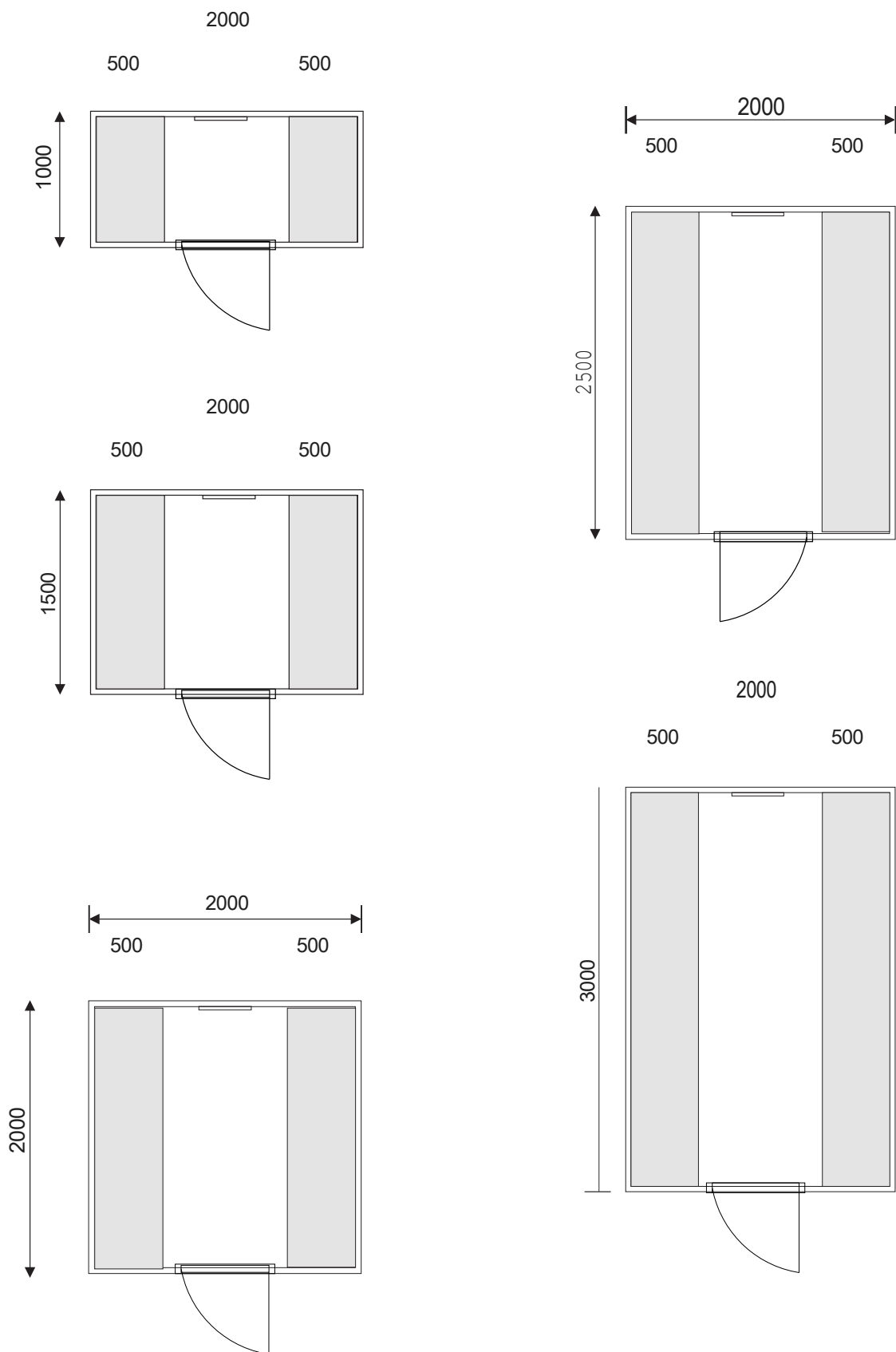

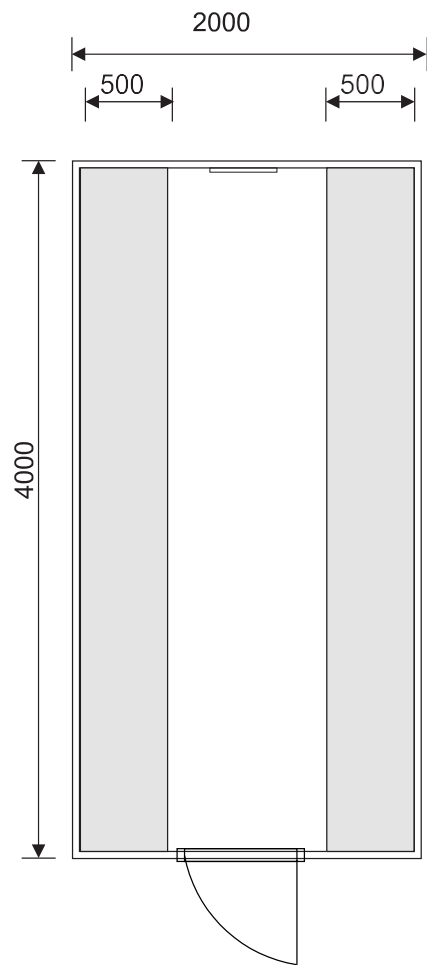
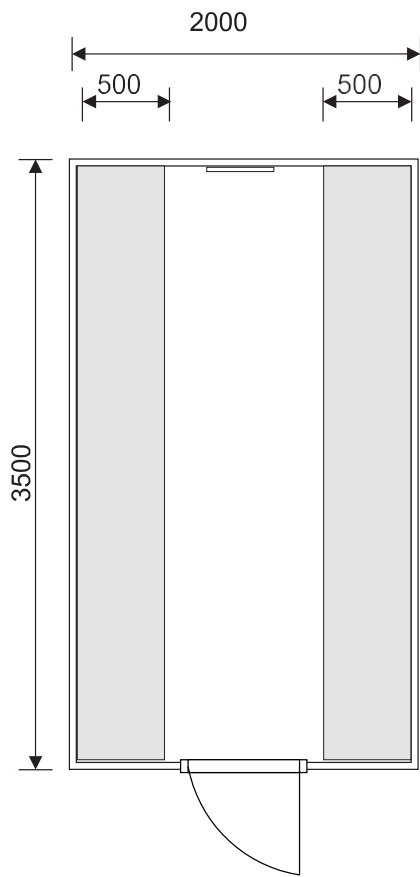

Other layouts on request

note: longer benches (> 2000 mm will be divided)

VOGUE LINE DRAWINGS

MODEL 2500

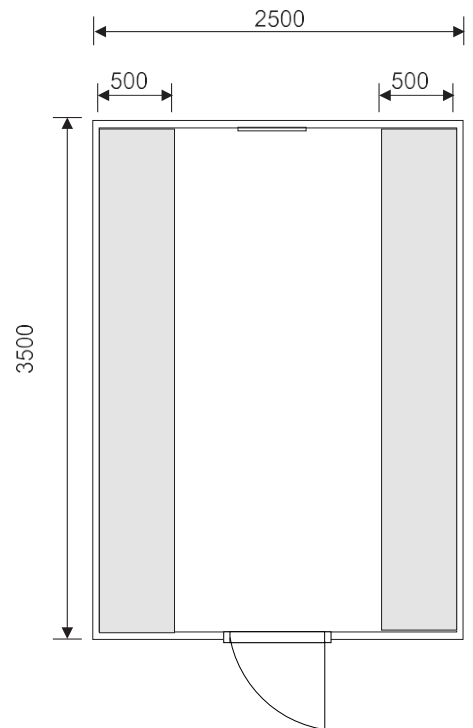
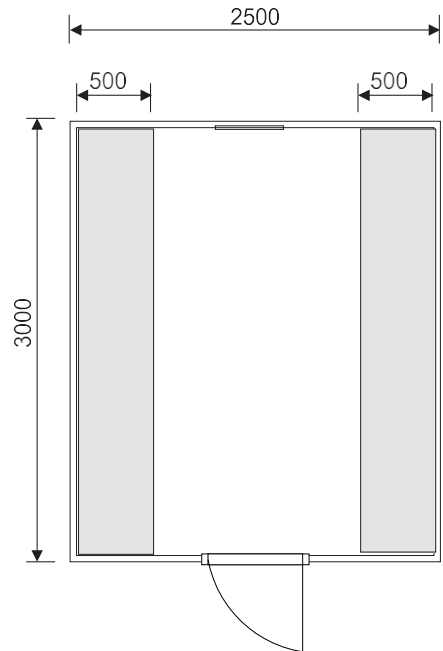
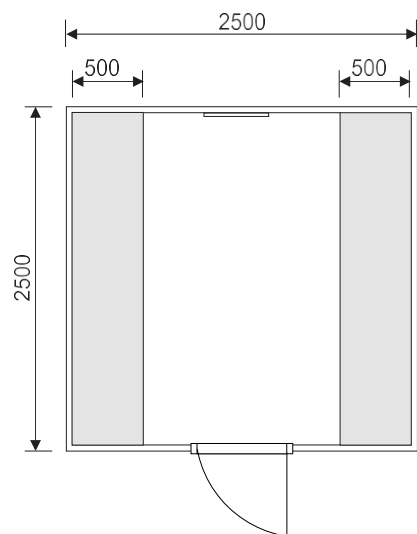
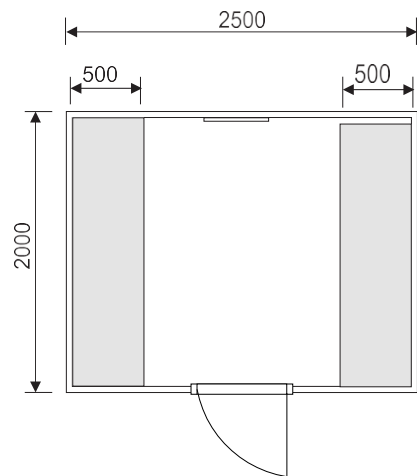
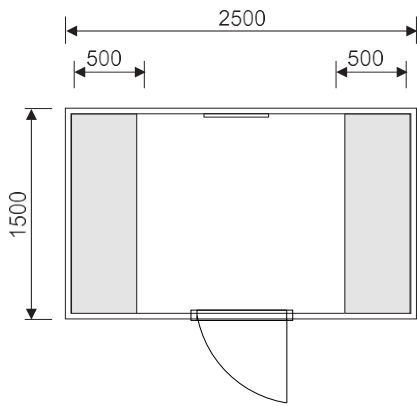

Other layouts on request

note: longer benches (> 2000 mm will be divided)

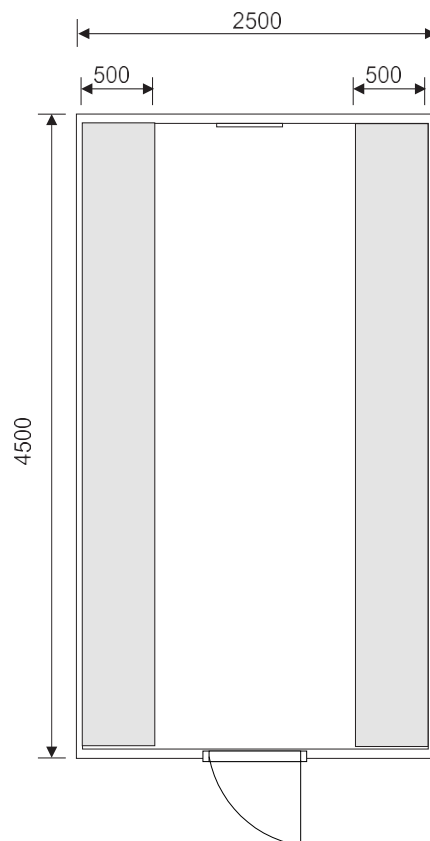
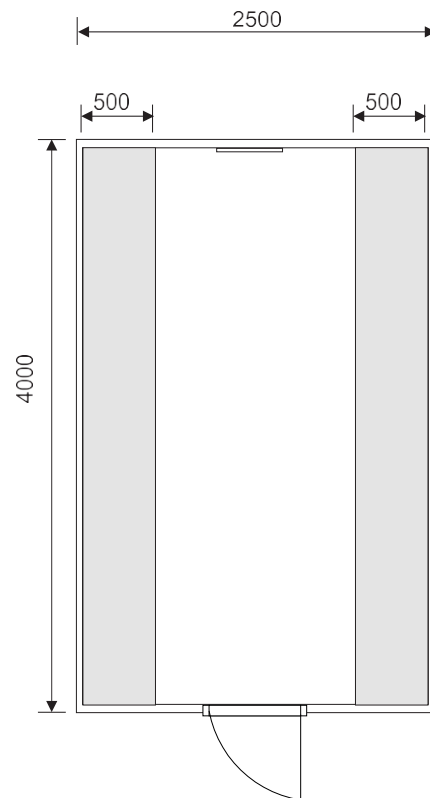

VOGUE LINE DRAWINGS

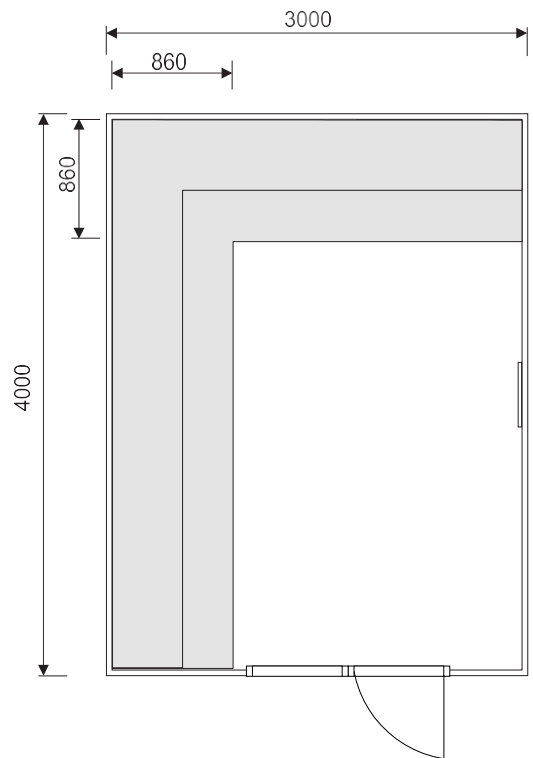
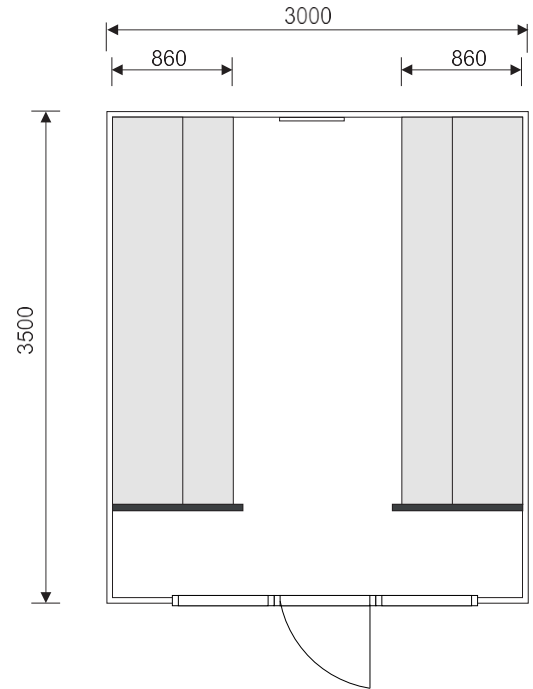
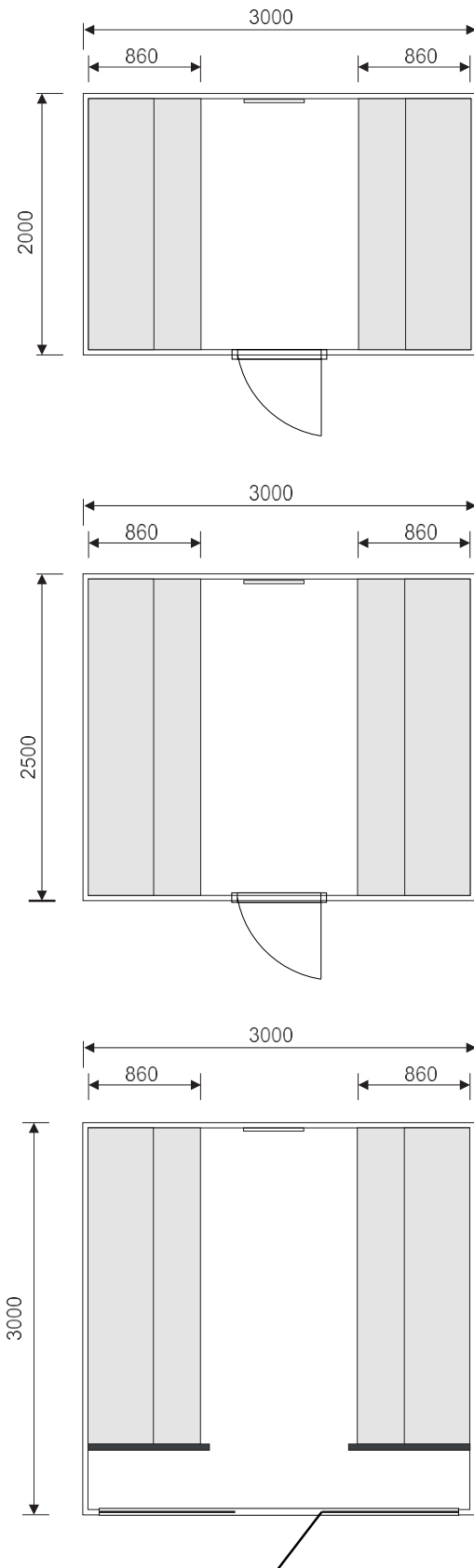

Other layouts on request

MODEL EXCLUSIVE 2500 & 3500

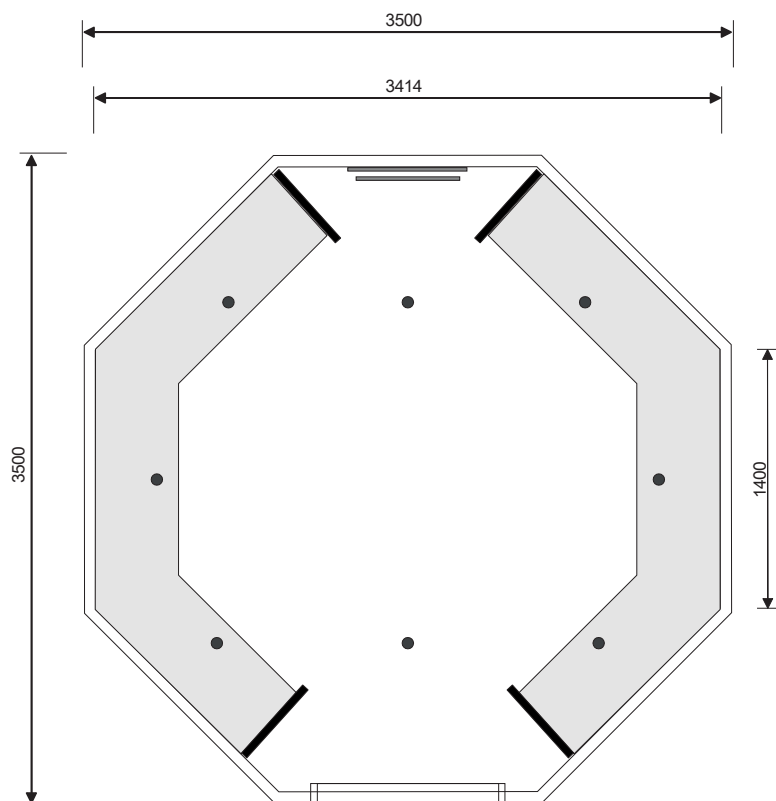
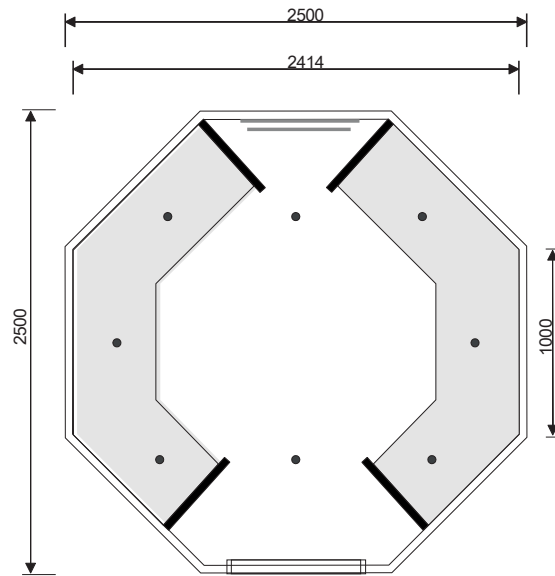

CLEOPATRA
world of wellness



EXTERNAL TOUCH DISPLAY



STEAM GENERATORS

Cleopatra's professional steam generators are based on the electrode principle and are used in many gyms, hotels, spas, etc. worldwide. With this steam generator, you can count on an excellent steam process, a long service life and easy maintenance. Exploded views and spare parts of these generators are available (see page 48).

FEATURES

- Stainless steel housing
- Easy to use Easy to maintain
- Error message via LED or display
- From 4 kg/h up to 45 kg/h
- Optional: Ultrasteam, LED lighting, Clean Aqua, Climate Control, Turbo steam, Touch display, Software Cleo App., Bluetooth music.

MODELS

Cleo Basic pro

Cleo Vital pro (new)

Cleo total pro

Cleo Elite pro (new)

CLEO BASIC PRO

The Cleo Basic^{PRO} is a professional generator used in many gyms, hotels, spas, etc. With this steam generator, you can count on an excellent steaming process, a long service life and easy maintenance.

FEATURES

- Stainless steel housing
- Easy to use Easy to maintain
- Error message via LED or display From 4 kg/h up to 45

BASIC

- Steam on/off
- Fragrance dosage on/off
- Temperature setting (via potentiometer)
- Manual draining

DESCRIPTION**ARTICLE NO****VOLTAGE****POWER**

DESCRIPTION	ARTICLE NO	VOLTAGE	POWER
Cleo Basic 422	1907 00 00	1 - 230 V	4 kg/h - 3 kW
Cleo Basic 434	1907 00 01	3 - 400 V	4 kg/h - 3 kW
Cleo Basic 832	1907 00 02	3 - 230 V	8 kg/h - 6.1 kW
Cleo Basic 834	1907 00 03	3 - 400 V	8 kg/h - 6.1 kW
Cleo Basic 1562	1907 00 04	3 - 230 V	15 kg/h - 11.4 kW
Cleo Basic 1534	1907 00 05	3 - 400 V	15 kg/h - 11.4 kW
Cleo Basic 2362	1907 00 06	3 - 230 V	23 kg/h - 17.5 kW
Cleo Basic 2364	1907 00 07	3 - 400 V	23 kg/h - 17.5 kW
Cleo Basic 3262	1907 00 08	3 - 230 V	32 kg/h - 24.3 kW
Cleo Basic 3264	1907 00 09	3 - 400 V	32 kg/h - 24.3 kW
Cleo Basic 4564	1907 00 10	3 - 400 V	45 kg/h - 34.2 kW

DESCRIPTION	ARTICLE NO
Fragrance control (12V) for generator 3 - 6.1kW	2198 80 30
Fragrance control (12V) for generator > 11.4kW	2198 80 40
Fragrance tank 10 litres	2145 31 00
Surface-mounted lighting 12V - 25W white	3095 61 10
RGB/White LED spot driver (incl. push button + 4 spots 4W)	2185 00 10
RGB/Weiss LED track driver (incl. push button + 5 metres track)	2185 00 20
Press to Steam Standby (control box + LED (red, orange, green) + push button)	2198 89 00
Water filter	1958 56 40
Spare cartridge water filter	1958 56 41
Speaker diameter 6.5" - 4 ohms, max power 80 watts, RMS power: 60 watts	1957 63 50
Ultrasteam - Stand alone with push button and LED (red, orange and green)	2500 60 10



CLEO VITAL PRO

The Cleo Vital ^{pro}, the successor to the Cleo Basic ^{pro}, is a professional generator with almost the same components as the Cleo Basic but with a new controller and options. Through this new control, maintenance and adjustment of settings have become easier. The Vital Pro generator can also be equipped with an external touch panel (page 34). With this steam generator, you can count on an excellent steam process, a long service life and easy maintenance.

FEATURES

- Stainless steel housing
- Easy to use
- Low-maintenance
- Fault indication LED

BASIC

- Steam on/off
- Fragrance dosage on/off
- Lighting on/off
- Temperature setting (via potentiometer)
- Manual draining

OPTIO

- External touch panel (page 34)
- Institution management software
- Press for steam - Standby function
- Multi fragrance
- Clean Aqua System (CAS)
- Climate control
- Turbo Steam
- UltraSteam
- Bluetooth Sound module
- Control via Modbus / KNX

DESCRIPTION

ARTICLE NO

VOLTAGE

POWER

DESCRIPTION	ARTICLE NO	VOLTAGE	POWER
Cleo Vital 422	1907 01 00	1 - 230 V	4 kg/h - 3 kW
Cleo Vital 434	1907 01 01	3 - 400 V	4 kg/h - 3 kW
Cleo Vital 832	1907 01 02	3 - 230 V	8 kg/h - 6.1 kW
Cleo Vital 834	1907 01 03	3 - 400 V	8 kg/h - 6.1 kW
Cleo Vital 1562	1907 01 04	3 - 230 V	15 kg/h - 11.4 kW
Cleo Vital 1534	1907 01 05	3 - 400 V	15 kg/h - 11.4 kW
Cleo Vital 2362	1907 01 06	3 - 230 V	23 kg/h - 17.5 kW
Cleo Vital 2364	1907 01 07	3 - 400 V	23 kg/h - 17.5 kW
Cleo Vital 3262	1907 01 08	3 - 230 V	32 kg/h - 24.3 kW
Cleo Vital 3264	1907 01 09	3 - 400 V	32 kg/h - 24.3 kW
Cleo Vital 4564	1907 01 10	3 - 400 V	45 kg/h - 34.2 kW

DESCRIPTION	ARTICLE NO
Fragrance dosage (12V) 3 - 6.1kW	2198 80 30
Fragrance dosage (12V) 11.4kW >	2198 80 40
Fragrance tank 10 litres	2145 31 00
Fragrance tank (incl. pump and 10-litre tank)	2500 61 40
Multi fragrance dosing (3 pumps)	2500 61 50
RGB/White LED spot driver (incl. push button + 4 spots 4W)	2185 00 10
RGB/Weiss LED track driver (incl. push button + 5 metres track)	2185 00 20
Press for steam (standby control) - LED (red, orange, green) + push button	2198 89 00
Water filter	1958 56 40
Spare cartridge water filter	1958 56 41
Bluetooth module incl. speaker	8100 50 90
Ultrasteam (RS485)	2500 60 20
Turbo Steam	2500 53 00
Climate control	2500 56 00
Clean Aqua System (CAS) excl. nozzles (max 8 nozzles)	2500 57 00
Aqua nozzle (each)	3094 13 18
External Touch control panel	3018 60 50
Home automation - KNX module	2500 53 50



CLEO TOTAL PRO**CLEO TOTAL PRO**

The Cleo Total ^{PRO} is a professional generator used in many gyms, hotels, spas, etc. With this steam generator, you can count on an excellent steaming process, a long service life and easy maintenance.

FEATURES

- Stainless steel housing
- Easy to use
- Low-maintenance
- Fault indication LED

BASIC

- Steam on/off
- Fragrance dosage on/off
- Lighting on/off
- Temperature setting (via display)
- Manual draining

OPTIONAL FUNCTIONS

- Climate control
- Clean Aqua System
- Standby function - press for steam

DESCRIPTION**ARTICLE NO****VOLTAGE****POWER**

DESCRIPTION	ARTICLE NO	VOLTAGE	POWER
Cleo Total 422	1907 00 20	1 - 230 V	4 kg/h - 3 kW
Cleo Total 434	1907 00 21	3 - 400 V	4 kg/h - 3 kW
Cleo Total 832	1907 00 22	3 - 230 V	8 kg/h - 6.1 kW
Cleo Total 834	1907 00 23	3 - 400 V	8 kg/h - 6.1 kW
Cleo Total 1562	1907 00 24	3 - 230 V	15 kg/h - 11.4 kW
Cleo Total 1534	1907 00 25	3 - 400 V	15 kg/h - 11.4 kW
Cleo Total 2362	1907 00 26	3 - 230 V	23 kg/h - 17.5 kW
Cleo Total 2364	1907 00 27	3 - 400 V	23 kg/h - 17.5 kW
Cleo Total 3262	1907 00 28	3 - 230 V	32 kg/h - 24.3 kW
Cleo Total 3264	1907 00 29	3 - 400 V	32 kg/h - 24.3 kW
Cleo Total 4564	1907 00 30	3 - 400 V	45 kg/h - 34.2 kW

DESCRIPTION

ARTICLE NO

Fragrance dosage (12V) 3 - 6.1kW	2198 80 30
Fragrance dosage (12V) 11.4kW >	2198 80 40
Fragrance tank 10 litres	2145 31 00
Fragrance tank (incl. pump and 10-litre tank)	2500 61 40
Lights built up 12V - 25W white	3095 61 10
Ultrasteam - Stand alone with push button and LED (red, orange and green)	2500 60 10
Press to steam (standby control) - LED (red, orange, green) + push button	2198 89 00
Water filter	1958 56 40
Spare cartridge water filter	1958 56 41
Climate control	2500 56 00
Clean Aqua System (CAS) excl. nozzles (max 8 nozzles)	2500 57 00
Aqua nozzle (each)	3094 13 18



CLEO ELITE PRO

The Cleo Elite ^{PRO}, the successor to the Cleo Total ^{PRO}, is a professional generator with the same components as the Cleo Total but with a new control system. With this new control system, maintenance and settings can be easily kept up to date via our configurator. With this steam generator, you can count on an excellent steam process, a long service life and easy maintenance.

FEATURES

- Stainless steel housing
- Easy to use
- Low-maintenance
- Fault indication LED

BASIC

- Steam on/off
- Fragrance dosage on/off
- Lighting on/off
- Temperature setting (via potentiometer)
- Manual draining
- Readout via USB B port

OPTIO

- Institution management software
- Press for steam - Standby function
- Multi fragrance
- Clean Aqua System (CAS)
- Climate control
- Turbo Steam
- UltraSteam
- Bluetooth Sound module
- Control via Modbus / KNX

DESCRIPTION	ARTICLE NO	VOLTAGE	POWER
Cleo Elite 422	1907 00 40	1 - 230 V	4 kg/h - 3 kW
Cleo Elite 434	1907 00 41	3 - 400 V	4 kg/h - 3 kW
Cleo Elite 832	1907 00 42	3 - 230 V	8 kg/h - 6.1 kW
Cleo Elite 834	1907 00 43	3 - 400 V	8 kg/h - 6.1 kW
Cleo Elite 1562	1907 00 44	3 - 230 V	15 kg/h - 11.4 kW
Cleo Elite 1534	1907 00 45	3 - 400 V	15 kg/h - 11.4 kW
Cleo Elite 2362	1907 00 46	3 - 230 V	23 kg/h - 17.5 kW
Cleo Elite 2364	1907 00 47	3 - 400 V	23 kg/h - 17.5 kW
Cleo Elite 3262	1907 00 48	3 - 230 V	32 kg/h - 24.3 kW
Cleo Elite 3264	1907 00 49	3 - 400 V	32 kg/h - 24.3 kW
Cleo Elite 4564	1907 00 50	3 - 400 V	45 kg/h - 34.2 kW

DESCRIPTION

ARTICLE NO

Fragrance dosage (12V) 3 - 6.1kW	2198 80 30
Fragrance dosage (12V) 11.4kW >	2198 80 40
Tank 10 litres	2145 31 00
Fragrance tank (incl. pump and 10-litre tank)	2500 61 40
Multi fragrance dosing (3 pumps)	2500 61 50
RGB/White LED spot driver (incl. push button + 4 spots 4W)	2185 00 10
RGB/Weiss LED track driver (incl. push button + 5 metres track)	2185 00 20
Press to steam (standby control) - LED (red, orange, green) + push button	2198 89 00
Water filter	1958 56 40
Spare cartridge water filter	1958 56 41
Bluetooth module incl. speaker	8100 50 90
Ultrasteam (RS485)	2500 60 20
Climate control	2500 56 00
Clean Aqua System (CAS) excl. nozzles (max 8 nozzles)	2500 57 00
Aqua nozzle (each)	3094 13 18
Turbo Steam	2500 53 00
KNX - Modbus module	2500 53 50



ULTRASTEAM

DENSE CLOUDS OF STEAM

The Ultrasteam generator was conceived and designed to achieve the ultimate steam experience: thick clouds of steam and a wonderful temperature of around 48 degrees Celsius. The Ultrasteam technology temporarily lowers the temperature but increases humidity. This keeps the steaming process naturally balanced.

The Ultrasteam generator can cooperate with various Cleopatra steam generators, making it also possible to connect the Ultrasteam to existing installations.

SAVE ENERGY

For hotels, public swimming pools and public facilities, it is possible to save significantly on energy costs. The Ultrasteam and Cleopatra steam generators can be tuned to provide a short heating time and full clouds of steam are created. This eliminates the need to run the plant all day. This saves maintenance and energy costs.

TECHNICAL SPECIFICATIONS

- 1 x 230V
- Cold water connection

DESCRIPTION	ARTICLE NO	VOLTAGE
-------------	------------	---------

Ultrasteam ST-A (stand alone) with push button and LED (red, orange and green)	2500 60 10	1 x 230 V
Ultrasteam (RS 485 version)	2500 60 20	1 x 230V

OPERATION OF THE ULTRASTEAM IN 4 IMAGES

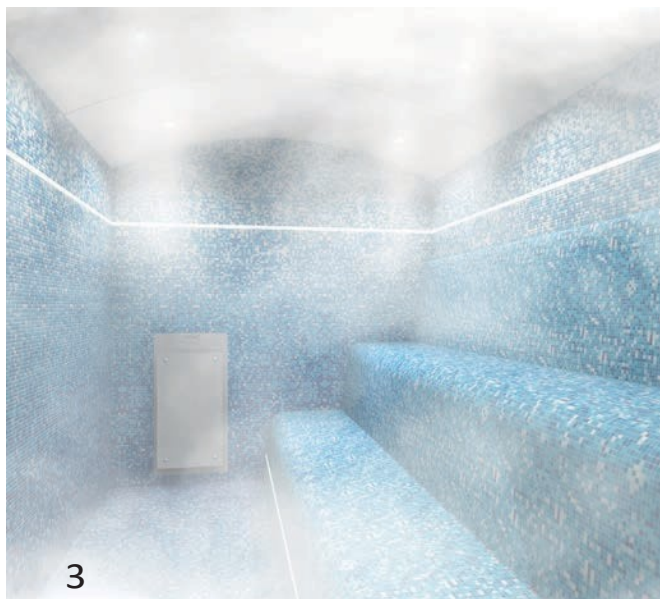
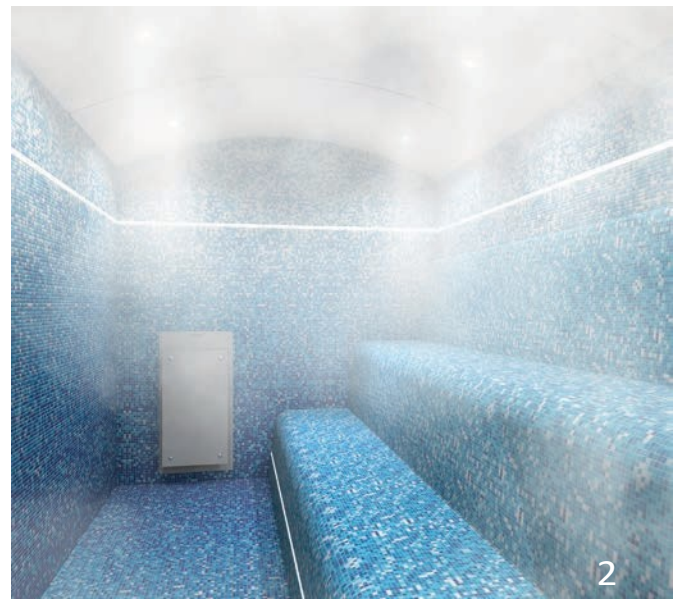

CLIMATE CONTROL

The climate in a steam bath is different in almost every situation; it depends not only on the size of the cabin but also on the humidity and temperature in the room. To create an optimal steam bath, the options below can be a good addition.

Turbo steam

Cold air is added to the steam to assist the steaming process. This increases condensation in the steam bath, creating a pleasant climate. Also, the steam is blown further into the cabin.

Climate control

If the temperature in the steam bath quickly rises to the set maximum temperature, the generator switches off, which may cause an irregular steaming process. The Climate Control switches on above the set temperature and, by means of a fan, causes the temperature to drop below the desired temperature. This will cause the steam generator to switch on earlier and once again bring steam into the cabin.

UltraSteam

When steam baths are used continuously and the condensation point is raised, you get less visible steam in the cabin. The Ultrasteam generator blows cold mist into the cabin, lowering the condensation point, resulting in thick clouds of steam. Besides this effect, using the Ultrasteam also temporarily lowers the temperature in the cabin, allowing new steam to enter the cabin quickly.

Also ideal in combination with the Press for Steam function; to create a steam bath full of pleasant clouds of steam at the right temperature in no time.

HYGIENE

Clean Aqua System (CAS)

The Clean Aqua system ensures that the seats in the steam bath are rinsed with water via a nozzle. The cabin is then ready for the next user. After a certain set time period, the system is activated automatically.

FRAGRANCE DOSAGE

Multi fragrance module

Besides the single fragrance module, it is also possible to apply a multi-odour module. If fragrance needs to be changed frequently, this is an easy-to-operate option (up to 3 fragrances). Easy to set via the external control panel, intensity and fragrance choice.

SAVE ENERGY

Press for Steam

If the steam bath needs to be switched on and off at irregular times, the Press for Steam is an ideal solution. The steam generator remains on standby at a base temperature, pressing a button outside the cabin brings the generator out of standby and starts steam production immediately. Ideal for hotels and places where visitor numbers fluctuate. Besides energy consumption, this also saves in generator maintenance. More information page 62.

MUSIC

Bluetooth module

Besides the possibility of installing speakers in a steam bath, it is also possible to play music via a Bluetooth module. Simply connect via a phone or tablet and enjoy your favourite music.

CONTROL VIA EXTRENAL SOURCE

KNX home automation module

With the new generation of steam generators, the Cleo Vital pro and the Cleo Elite pro, it is possible to control the generator via home automation, KNX. Ask about the possibilities.

Signal 4-20 mA / 0-10 V

With the new generation of steam generators, the Cleo Vital pro and the Cleo Elite pro, it is possible to control the generator via 4-20 mA / 0-10V signal. Ask about the possibilities.

CLEO TOTAL EXPLODED OVERVIEW

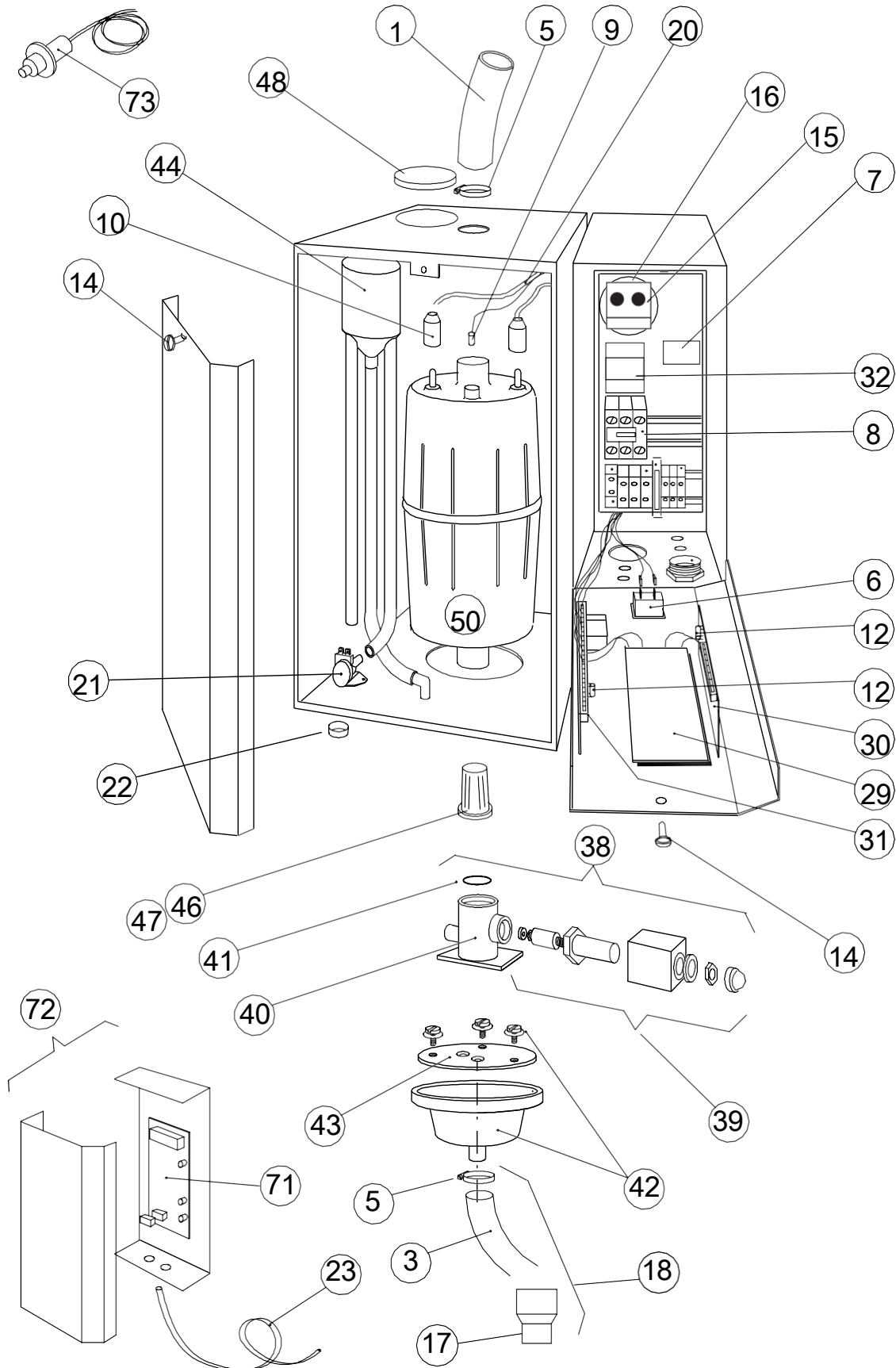

CLEO VITAL & ELITE EXPLODED OVERVIEW

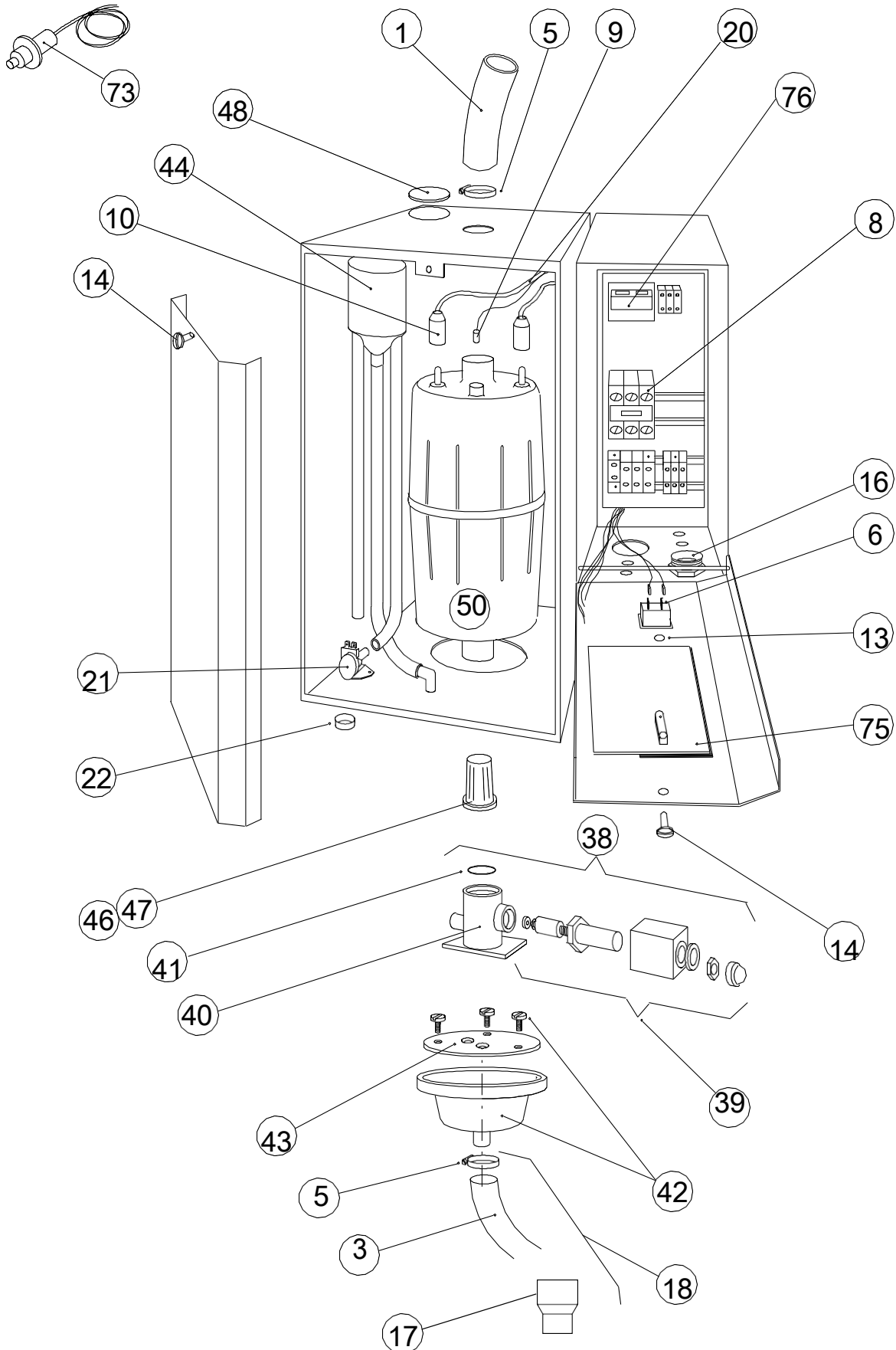

SPARE PARTS GENERATORS

#	ARTICLE NO	DESCRIPTION
1	11000000	Steam hose 22/31 mm - 1 metre
1	11000001	Steam hose 35/44 mm - 1 metre
3	11000003	Drain hose 22 mm
9	12590670	Water level plug (10 pieces)
6	12591403	Switch 2 positions (on/off)
6	12591409	Switch 3 positions
8	12591431	Siemens contactor 3RT 2023
8	12591434	Relay 3RT 1035 (13064)
7	12591502	Transformer 230/24V
16	12591505	Toroidal transformer 230/12V
41	12690000	O-ring for exhaust valve (10 pieces)
5	12990290	Hose clamp 29 mm (5 pieces)
5	12990291	Hose clamp 43 mm (5 pieces)
5	12990292	Hose clamp 46 mm (5 pieces)
48	12990634	Lid for filling cup
43	13840019	Exhaust plate
22	13840026	Filter for inlet valve (5 pieces)
39	16291050	Operator and coil 230 V complete
44	16291100	Water filling system 4 - 8 kg/h
44	16291101	Water filling system 15 - 23 kg/h
44	16291102	Water filling system 32 - 45 kg/h
50	16291200	Cylinder 422 / 240
50	16291201	Cylinder 424 / 260
50	16291202	Cylinder 432
50	16291203	Cylinder 434
50	16291300	Cylinder 822
50	16291301	Cylinder 824 / 360
50	16291302	Cylinder 832
50	16291303	Cylinder 834 / 370
50	16291400	Cylinder 1562
50	16291401	Cylinder 1534
50	16291500	Cylinder 2362

SPARE PARTS GENERATORS

#	ARTICLE NO	DESCRIPTION
50	16291501	Cylinder 2364
50	16291600	Cylinder 3262
50	16291601	Cylinder 3264
50	16291700	Cylinder 4564
50	16291750	Cylinder 4565
50	16291800	Cylinder 6564
42	16293000	Exhaust cup with screws
20	16490100	Wiring harness 432, 434, 832, 834
20	16490101	Wiring harness 422, 424, 824
20	16490102	Cable harness 822
20	16490103	Wiring harness 1534
20	16490104	Cable harness 1562, 2364
20	16490105	Cable harness 2362
20	16490106	Cable harness 3264
20	16490107	Cable harness 3262, 4564
20	16490109	Cable harness 13064
10	16498000	Electrode plug
13	16499100	LED 2 colours
40	16890000	Exhaust valve body incl. recess
46	16890001	Sieve cylinder fine
47	16890002	Sieve cylinder standard
	17740006	Processor print Easy
29	17740008	Processor board DT-12
71	17740011	Processor print remote control external
15	17740020	Power supply PCB 12V fragrance doser
29	17740021	Processor print Cleo Total
30	17740023	Relay board DT-12
31	17740027	Supply print Cleo Total / DT-12
30	17740028	Relay board Cleo total

GENERATOR SIZES

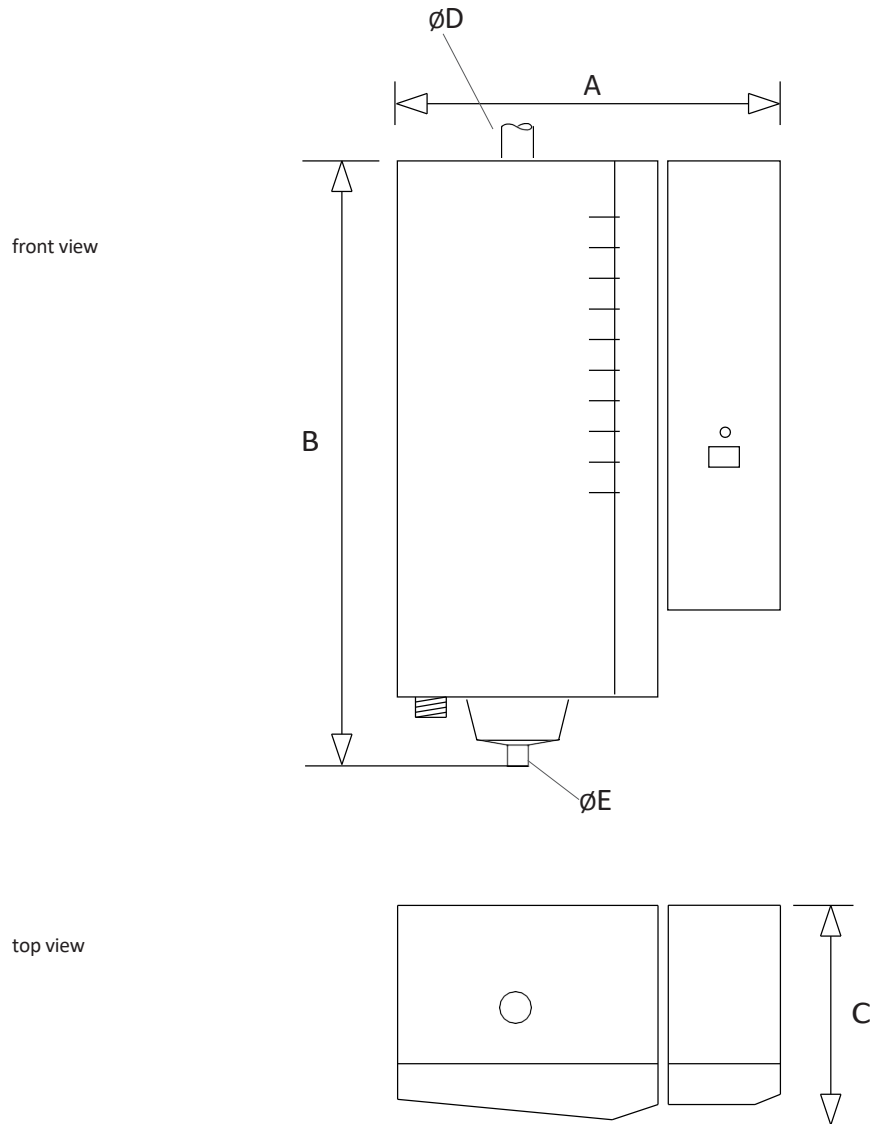

Type	kW	A (mm)	B (mm)	C (mm)	D (∅ mm)	E (∅ mm)
4	3	370	590	215	1 x 22	1 x 22
8	6,1	370	590	215	1 x 22	1 x 22
15	11,4	440	640	300	1 x 35	1 x 22
23	17,5	440	640	300	1 x 35	1 x 22
32	24,5	480	680	340	1 x 35	1 x 22
45	34	480	680	340	2 x 35	1 x 22

WATER QUALITY

WATER QUALITY

For proper operation of the electrode generators, it is important that there is sufficient conductivity in the water (measured in micro siemens / cm). The use of filters and softeners can strongly influence the conductivity and thus the steaming process. If in doubt, we recommend measuring the water with the measuring equipment available on the market for this purpose.

Recommended water conductivity: 125 - 1250 micro Siemens / cm (salinity) Water

hardness: 7 - 14 ^{oDH} or 1.3 - 2.5 mmol / l

DRAIN

Use 'pressure PVC' for the first 2 metres because of temperatures up to 100 °C.

ARCHITECTURAL CABINS

For architectural cabins, always specify a minimum ambient temperature of 20 degrees °C. It is recommended to provide architectural cabins with insulation panels. In addition, good ventilation is extremely important for the steaming process.

POWER VERSUS CONTENT

CAPACITY - CUBIC METRES (CABIN VOLUME)

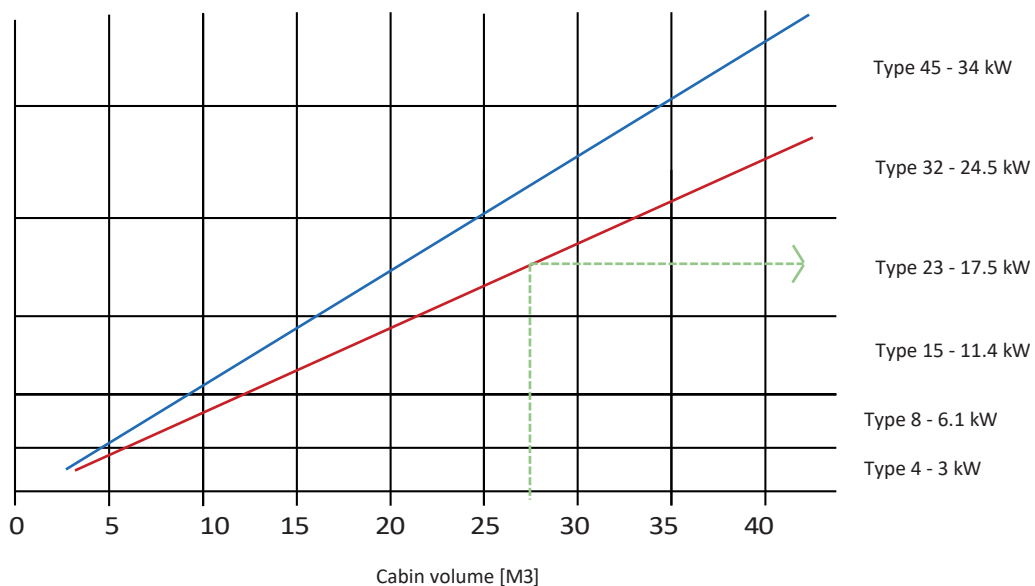

— Architectural cabins Cleopatra
— cabins

WELLNESS AUTOMATION

Wellness automation with the Master Controller Pro

You can fully automate the steaming process with the Master Controller Pro (MCP). It automates the entire steaming process according to a number of easily adjustable steps in accordance with the customer's wishes. Software-wise, with the Cleopatra app (windows), the following values can be set customer-specifically to create the optimum experience:

Steam function:

- Steam time setting
- Temperature setting
- Warm-up function for jump-starting

Climate control:

- For stable temperature in the cabin
- Adjustable 40 - 50 oC
- On / off

Lighting:

- Connection 4 x 4 Watt LED white (standard)
- Cleo RGB LED spot module (via RS 485) - jumper setting for white LED display
- Cleo RGB LED track module (via RS 485) - jumper setting for white LED display

Special features:

- Shower function end of steam session
- Clean Aqua System: for rinsing banks after steaming session
- Cleo Bluetooth audio module (only with Cleo Steambrain ^{pro})
- Time Scheduler (real time): controls on/off times 7 days a week, up to 3 time slots per day adjustable

Fragrance:

- Cleo fragrance controller 1 pump or (in combination with Touch control Deluxe up to 4 pumps with emptying function

Ultrasteam:

- Ultrasteam provides a true unbeatable steam sensation: thick clouds of steam!

Operating options:

- Press for steam operation (push button + LED indication red/green)
- Coin mechanism
- Nayax payment terminal and telemetry

Status indication:

- The status indication reads off how long the system has been in operation and how many times it has been switched on. The set process can be followed closely and error messages are displayed via codes.

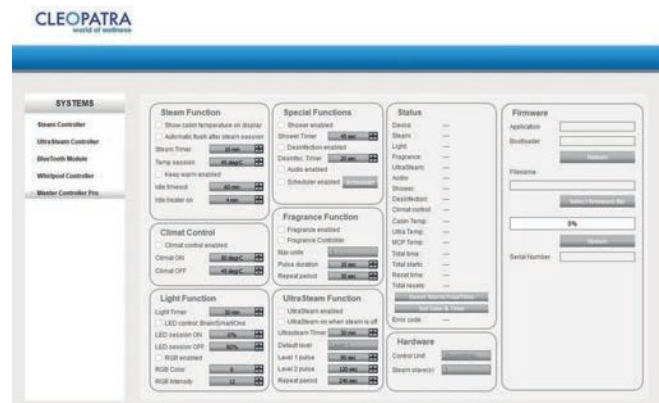



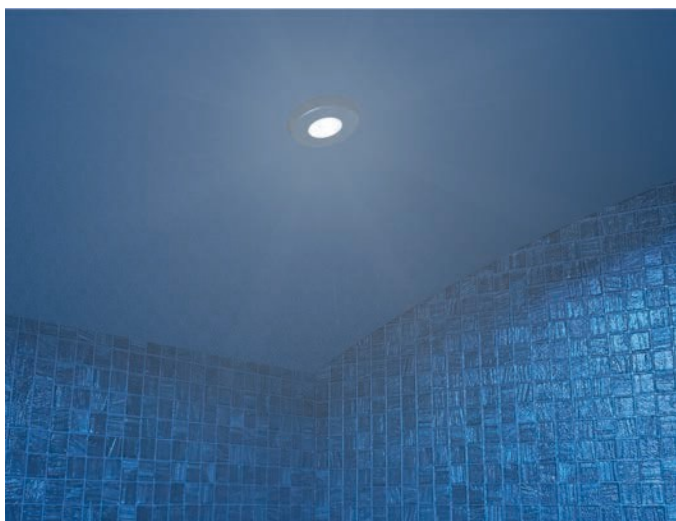

103 White LED spotlight

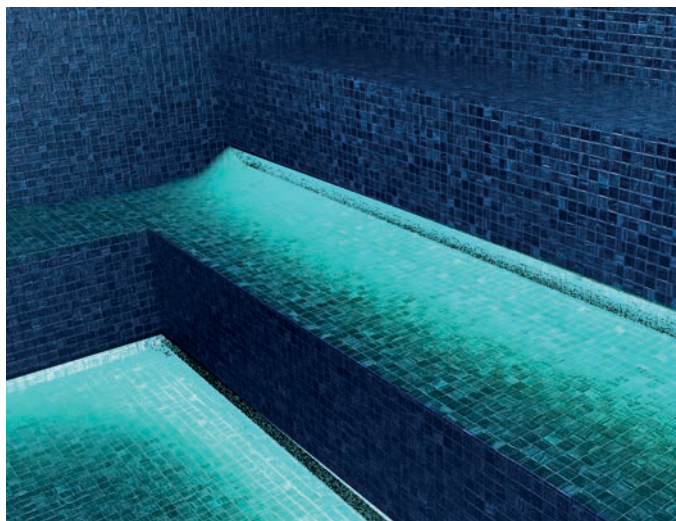

105 RGB LED rails



116 Wellness shower

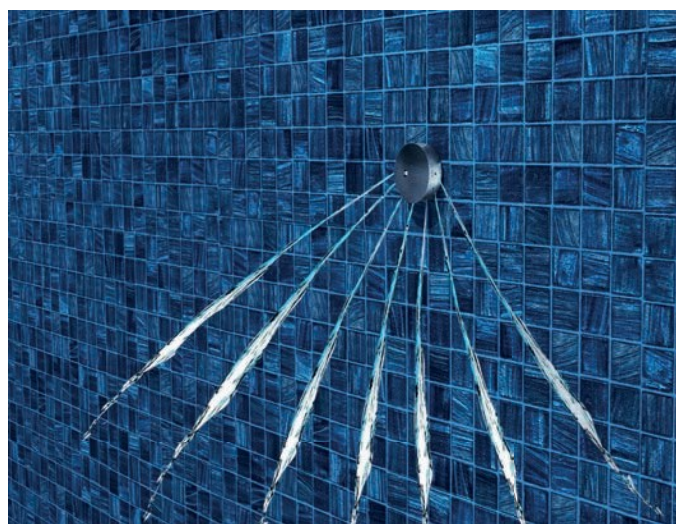

115 Clean Aqua System (CAS)



117 Bluetooth audio module + speakers



113 Ultrasteam



119 Press to steam



120 Coin taster

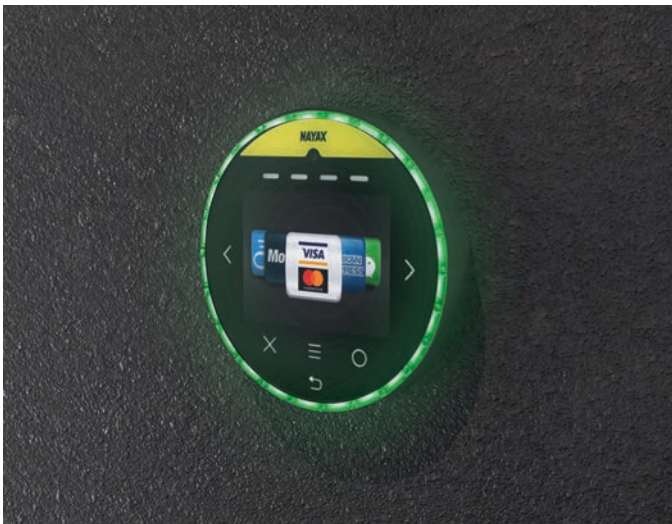

121 Nayax payment module



108 Steam inlet glass RAL 9016



108 Steam inlet glass RAL 7042

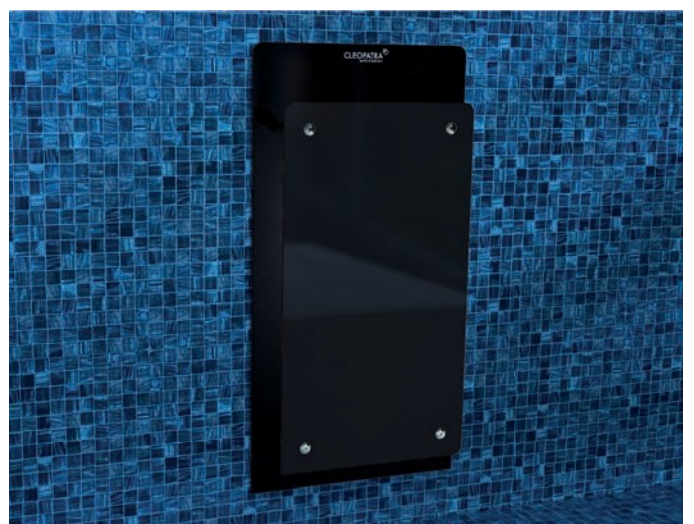

108 Steam inlet glass RAL 7021



ONYX PAYMENT TERMINAL & TELEMETRY

With the Onyx, you have a payment terminal that accepts a wide range of payment methods such as contactless bank cards, credit cards, Apple Pay, NFC and mobile payment apps, WeChat Pay, Alipay and prepaid cards. Thanks to integrated telemetry, you as an operator can easily monitor and manage with the back office system. You can remotely update prices and change product names.

Specifications

- Contactless/cashless payments
- Easy navigation with colour touchscreen, graphics and text
- Works with all well-known local payment providers
- NFC and mobile payment apps
- Contactless card reader and telemetry device in one compact device

Telemetrie

- 1 PIN contract for all bank cards, credit cards, Apple Pay etc. (need not be concluded separately)
- Adjusting prices remotely
- Extensive analysis tools
- Terminal updates
- App for smartphone or tablet
- Synchronised with desktop management system



ENERGY SAVINGS

It is one of the most important challenges of our time; saving energy. Allowing the customer to enjoy a soothing steam bath to the full but only allowing the steam bath to function when needed. To achieve this, Cleopatra has developed a number of savings options.

With the Cleopatra Standby and pre-heat function, you save on energy costs without having to compromise on comfort and quality of the steaming process.

- Press for steam: standby control that keeps the steam generator at temperature and produces steam immediately after activation by the end user.
- Ultrasteam: a complement to press for steam if the steam image (thick clouds of steam) needs to be achieved in a very short time.

FIGURE 1 TRADITIONAL CONTINUOUS STEAM PROCESS

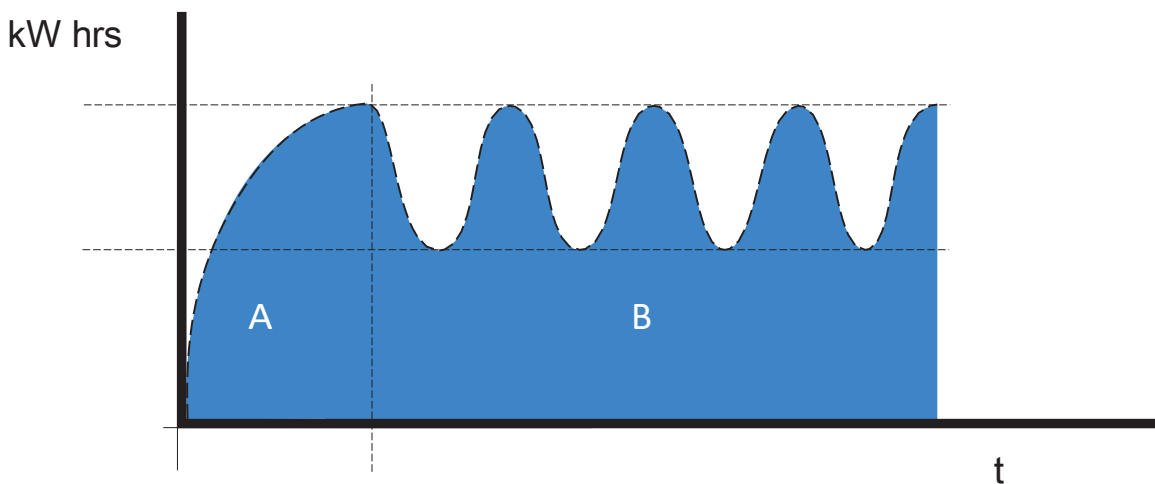

FIGURE 1

A. When the steam generator is switched on, it will start heating until the set temperature is reached. After this phase, the generator will continue to heat up as soon as the temperature drops a few degrees Celsius.

B. The generator requires less power (kW hours) to maintain the desired temperature in the cabin.

* kW hrs = consumption (kW) per hour

FIGURE 2 STANDBY FUNCTION

- A. When the steam generator is switched on, it starts to heat up via the preheat function (=preheating phase).
 - B. This area in Figure 2 (under B) is the minimum energy required to keep the generator at temperature. On activation by the end user, the steam process starts immediately.
 - C. Initiated start by steam room user
- To support the steam process, an ultrasteam generator can be fitted (page 44). The ultrasteam creates a steam bath at temperature with thick clouds of dense steam.

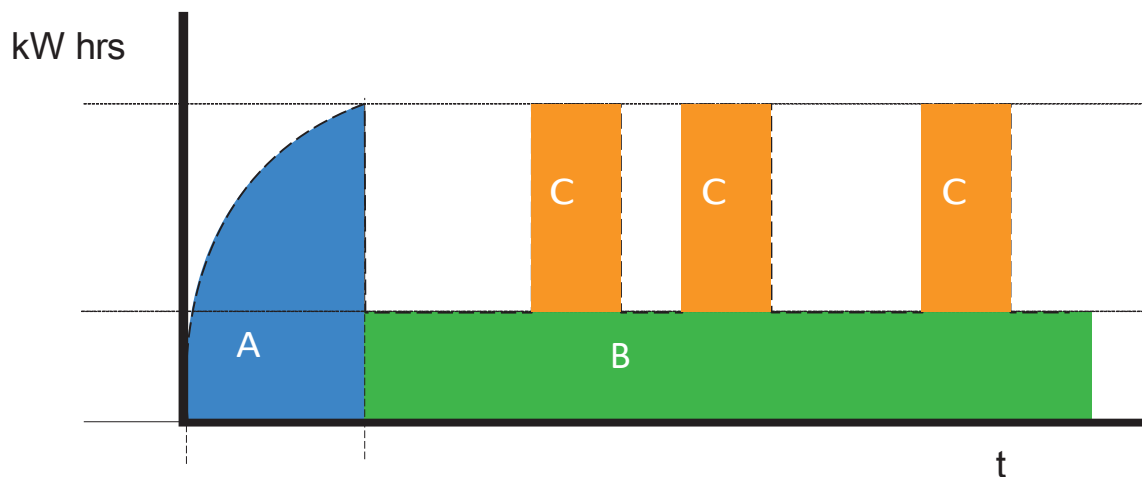

ENERGY SAVING EXAMPLE

Steam generator with an output of 11.4 kW runs 16 hours a day - 7 days a week

Total kW per year = $11.4 \times 16 \times 7 \times 52 = 66,393$ kWh (x 55% average consumption after start-up (Figure 1-B) = 36,516 kWh

With Cleopatra savings system (figure 2-B): Max consumption $66,393$ kWh x 30% = 19,918 kWh

Difference: $36,516 - 19,918 = 16,598$ kWh (this is the saving 45% in this example)

Savings obviously depend on a number of factors: number of users, duration of the steam session, power of the generator. The calculation is for illustrative purposes only.

FRAGRANCES

DESCRIPTION	ARTICLE NO
BATH OILS AND CLEANERS	
Mediterranean sea 250 ml	2216 51 10
Cleopatra's perfume 250 ml	2216 51 20
Dried Wood 250 ml	2216 51 30
Bergamot 250 ml	2216 51 40
Eucalyptus 250 ml	2216 51 45
Set of 5 different scents (5 x 250 ml)	2216 51 50
Whirlpool cleaner 1 litre	2216 53 40
Acrylic Polish 500 ml	2216 53 60
SAUNA FRAGRANCES	
Eucalyptus 250 ml	2216 51 60
Lavender 250 ml	2216 51 70
Rosemary 250 ml	2216 51 80
Bergamot 250 ml	2216 51 90
Pine 250 ml	2216 51 95
Set of 5 different scents (5 x 250 ml)	2216 51 98
Eucalyptus 5 litres	2216 52 00
Pine 5 litres	2216 52 10
Rosemary 5 litres	2216 52 20
Lavender 5 litres	2216 52 30
STEAM BATH FRAGRANCES	
Eucalyptus milk 5 litres (concentrate)	2145 30 50
Eucamint milk 5 litres (concentrate)	2145 40 50
Lemongrass milk 5 litres (concentrate)	2145 40 60
Salt solution Mediterranean sea 5 litres	2216 54 00
Salt solution Cleopatra 5 litres	2216 54 50



Eucalyptus
ESSENTIAL OIL

DATA SHEETS VOGUE CABIN

MODELS	
	Vogue Essential
	Vogue Comfort
	Vogue Superior
	Vogue Exclusive
MATERIALS	
WALLS & BENCH	<ul style="list-style-type: none"> - 43 mm isolated sandwich panel with heat and scratch resistant aluminium composite surface. - Highly hygienic - easy to clean and maintain. - 10 standard colours: shiny white, shiny grey, structured white, structured graphite grey, structured metal rust, structured mediterranean beige, structured terra grey, marble white matt, marble black matt, concrete grey matt.
ROOF	<p>Flat insulated roof: 43 mm in RAL colour Doomed insulated roof: 43 mm in RAL colour</p>
BY	<ul style="list-style-type: none"> - Aluminium framed door, with threshold and tempered safety glass. - Aluminium door handle - in RAL colour
WINDOWS	Alumium framed windows with tempered saftey glass 8 mm
LIGHTS	<p>2 x LED RGB strips along the roof (sides) - IP 67 2 x LED RGB strips along the benches - IP 67</p> <p>Lights are dimmable, automatic colour rotation for light therapy</p>
VENTILATION	Natural ventilation shaft (adjustable)
STEAM INLET	<ul style="list-style-type: none"> - Safety glass steam inlet (white, black or grey) - Inclusive sticker indication: attention hot.
SIZES	<p>STANDARD SIZES Vogue 1250 width: 1250 mm Vogue 1500 width: 1500 mm Vogue 2000 width: 2000 mm Vogue 2500 width: 2500 mm Vogue 3000 width: 3000 mm</p> <p>MADE TO MEASURE: Possible on request</p>
HYGIENE	Easy to clean with soft cloth and maintain with water and neutral clean products (no acid).
CABIN STRUCTURE	The cabin consists of several panels and is prefabricated. The cabin can be placed - stand alone on a tiled or finished floor. Always provide a drain for water remains. Further ventilation of residual steam and moisture is needed.

DATA SHEETS STEAM GENERATORS

STEAM GENERATORS	
MODELS	Cleo Basic Pro Cleo Total Pro Cleo Vital Pro (NEW) Cleo Elite Pro (NEW)
TECHNOLOGY	- Electrode-based generator - Automated filling, draining cycle, heavy duty for daily use. - Technology in use since 1992 (Cleo Basic, Cleo Total)
MAINTANCE ADVISED	- Cylinder change (2x per year) - Draincup cleaning (2x per year) - Inlet valve (1 x year) - Outlet valve (1 x year) * maintance is dependent on water quality
GENERATOR	- Stainless steel housing - Easy to use - Maintance friendly - Faul message LED
POWER [kW / kg/h]	4 kg/h - 3 kW 8 kg/h - 6.1 kW 15 kg/h - 11.4 kW 23 kg/h - 17.5 kW 32 kg/h - 24.3 kW 45 kg/h - 34.2 kW - available in 3 x 230 V - 3 x 400 V - size of generator is depended on M3 of the cabin volume.
TEMPERATURE	40 - 50 0C - adjustable (cabin temperature)
STANDBY	Steam generator standy by - keep warm function
SCOPE OF DELIVERY	- inclusive: steam hose and temperature sensor - exclusive: mounting materials
LOCATION OF PRODUC-TION	Zaandam, the Netherlands
WARRANTY	Warranty of the steam generator 1 year.

Cleopatra offers the perfect wellness experience for individual spaces. Smart solutions for a range of unforgettable moments of personal well-being and relaxation.

If you want more information about Cleopatra, visit our website www.cleopatra.nl or contact the Cleopatra branch or partner in your country.

Cleopatra B.V. - Oostzijde 295 - 1508 EN Zaandam - The Netherlands
Tel. +31 (0)75 6478200 - info@cleopatra.nl - www.cleopatra.nl

Cleopatra

Cleopatra has been the Dutch manufacturer of luxury and high-quality wellness products since 1966. Our range consists of steam/shower cabins, customised steam solutions, baths, whirlpools, saunas, infrared cabins and spas. We serve both the consumer and the professional market. The most important source of inspiration for Cleopatra is water, whereby the consumer's need for relaxation comes first. In order to guarantee quality, all our products are manufactured in-house by professionals. In addition, we subject all manufactured products to an extensive and thorough quality test. With our passion for the product and years of experience, we guarantee the highest quality and durability of all Cleopatra products.

Showroom

To get a good impression of our products, a visit to our showroom and Wellness Experience Centre in Zaandam is highly recommended. Most of our range is conveniently presented here. Our experienced staff will be happy to advise you.

Wellness Experience Centre

Try out wellness products for the bathroom yourself. Shower, steam, sauna, infrared or bath, doesn't matter. Know the feel of the sparkling water, the beauty of the flowing design, the invigorating scents of the steam room and the massaging power of the latest whirlpool system.

Customised advice

To receive sound advice, we also offer you the possibility of a Cleopatra wellness advisor working with you in your home to look at the options for the ideal interpretation of your wellness space, you can contact the inside sales department to make a consultation appointment.

For more information call 075 - 6478200 or see www.cleopatra.nl